

# Polaritons in microstructured materials

Yongyuan Zhu

Lab. Of Solid State Microstructures

Nanjing Univ.

2010年11月11日

# Content

- Introduction
- Piezoelectric superlattice
  - Piezoelectric transducer
  - Polariton: Superlattice vibration
- Polariton in a plasmonic crystal
- Conclusions

## Polariton的中文翻译

英汉物理学词汇 (1978): 极化激元

固体物理学 (方俊鑫等, 1980): 声光子 (phonon-polariton)

英汉科学技术词典 (1991): 极化声子、偏振子

晶格振动光谱学 (张光寅等, 2001, 第二版): 电磁耦子

凝聚态物理学 (下卷, 初稿):

Phonon-Polariton: 极化声子

Exciton-polariton: 极化激子

.....

极化激元研究的进展—纪念黄昆先生90 诞辰

(甘子钊, 物理·38 卷 (2009年) 8期)

Polariton is a mixed state of photon and polarization wave

The polariton represents an interactive relationship between the light energy and the material polarization that it induces.

Light within a material is no longer just an optical field, it is now intimately linked with the optical response of the material, the mode is a polariton rather than a photon.

PRB 54, 6227 (1996)

**Electrons: Dispersion of refractive index**

**Ions: Infrared absorption etc.**

**Piezoelectric effect: related to ions displacement**

# POLARITON

1951: Proposed the phenomenon in an ionic crystal

Strong coupling exists between EM wave and transverse optical phonon!

K. Huang, *Proc. R. Soc. London A* **208**, 352 (1951)

1958: Coined the word “polariton”

J.J.Hopfield, *PR* **112**, 1555(1958)

It is of interesting to note that the term “polariton” was originally coined by Hopfield to designate the **“uncoupled polarization field particles”** of the medium. The term was, however, **misconstrued by Russian investigators as designating the coupled polarization excitation-photon modes**, and through extensive use in the Russian literature polariton has become the generic name for the coupled modes.

“The polarization field “particles” analogous to photons will be called “polaritons.” (Excitons will be shown to be one kind of polariton.... Optical phonons are another example of polaritons.)

J.J.Hopfield, PR 112, 1555(1958)

The propagating state for these energies and wave vectors can no longer be described as a phonon or a photon, but is a mixture of these two elementary excitations know as a polariton.

C.H.Henry, J.J.Hopfield, Phys.Rev.Lett.15, 964(1965)

# Exciton Polaritons

- If a light field and an exciton overlap, they affect each other.
- Light is an EM-field, and EM-fields affect charged particles, thus changes the behavior of the electron and the hole that make up the exciton.
- The charged particles create electric-fields, the exciton in turn affects the way the light behaves.
- If we match the energy of the light and excitons they become "entangled", and seem to become a pair of new and different objects. These are "polaritons".

# Surface polaritons

Modes that propagate along an interface with the amplitudes of the fields decreasing normal to the interface.

Surface polaritons are classified by the mechanism by which light is bound to the surface:

- Light modes bound to the surface through interactions between the photons and the free-electron gas in a metal are called electron-gas-driven polaritons or plasmon polaritons.
- Light bound to the surface through interactions between photons and phonons are called phonon-driven polaritons or phonon polaritons.



# Quantum-well polariton

It is the quantum-mechanical combination of the light in an optical-cavity and an exciton in a quantum-well.

## Phonon polaritons

- Transverse optical-phonon polariton
- Longitudinal optical-phonon polariton???

In an ionic crystal, impossible!

But in a piezoelectric superlattice, possible!

- 利用电子作为信息载体进行信息传输、处理和显示等的一系列技术革命，奠定了当代信息社会的**技术基础**。
- 用光代替电子作为信息载体，它在速度、信息载荷量、能耗方面有**内禀的优势**。
- 人工微结构材料通过对光子、声子能带结构进行裁剪，实现对光子、声子的强度、频率、位相、偏振和传播方向进行**操纵和控制**。

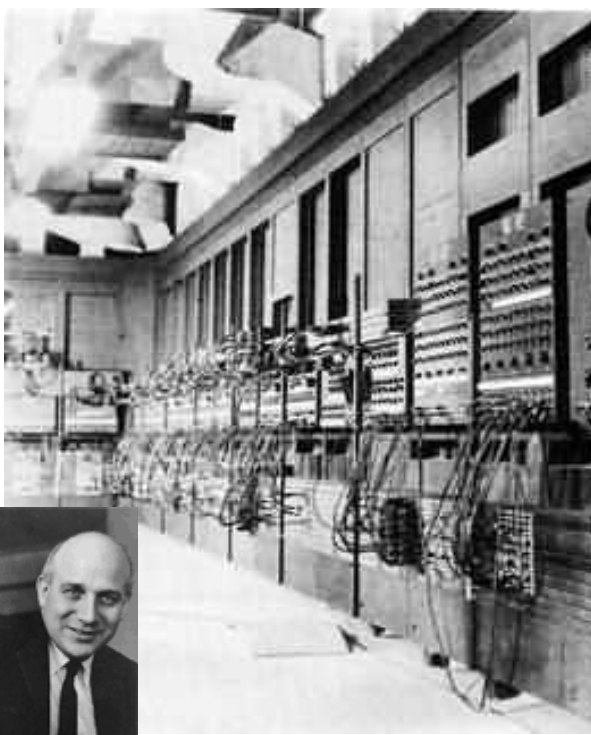

2月14日，一个特别的日子，空气都散发着浪漫的气息。不用多说，这个日子作为情人节已被世界公认。但鲜为人知的是，这天还发生过一个重大事件：有人认为世界上第一台电子计算机就在这天诞生。

在揭幕仪式上，Eniac为来宾表演了它的“绝招”——分别在1秒钟内进行了5000次加法运算和500次乘法运算，这比当时最快的继电器计算机的运算速度要快1千多倍。这次完美的亮相，使得来宾们喝彩不已。

埃克特（右）和莫克利（左）因共同研制成功ENIAC而名垂青史。

1946年2月14日，世界上第一台通用数字电子计算机ENIAC在宾州大学莫尔电机学院开始运行，宣告了电子计算机时代的开始。

当年，人们看到的ENIAC不是一台机器，而是满满一屋子的庞然大物，密密麻麻的开关按钮，东缠西绕的各类导线，忽明忽暗的指示灯，人们仿佛来到一间正在开工中的纺织车间。ENIAC有8英尺2高，3英尺宽，100英尺长，总重量有30吨之巨。



巴丁



肖克莱



布拉坦

巴丁1908年生于美国，16岁考上大学，特别喜欢物理。早年他和另外两名科学家肖克莱和布拉坦一起，共同研究半导体锗和硅的物理性质。在一次实验中，他在锗晶体上放置了一枚固定针和一枚探针，利用加上负电压的探针来检查固定针附近的电位分布。当巴丁将探针向固定针靠近到0.05毫米处时，突然发现，改变流过探针的电流能极大地影响流过固定针的电流。这一意外的发现，使他们意识到这个装置可以起放大作用。于是三人通力合作，经过反复研制，终于在1947年发明了一种新的半导体器件，这就是晶体管。这一成果立刻轰动了电子学界，巴丁等被称为电子技术革命的杰出代表。由于这一贡献，巴丁和肖克莱、布拉坦一起获得了1956年度诺贝尔物理学奖。

1958年，晶体管发明十周年之际，34岁的基尔比加入德州仪器公司。当时公司的工程师们因为受到晶体管发明的鼓舞，开始尝试设计高速计算机。晶体管的发明虽然意义重大，但问题还没有完全解决。应用晶体管组装的电子设备还是太笨重了，工程师设计的电路需要几英里长的线路和上百万个焊点，没有人能建造它们。个人拥有计算机仍然是一个遥不可及的梦想。针对这一情况，基尔比提出了一个大胆的设想：“可以在一个半导体单片上安置以下电子元器件：电阻、电容、晶体管等。”——一个叫做相位转换振荡器的简易集成电路。

1958年9月12日，基尔比成功地实现了把电子器件集成在一块半导体材料上的构想，研制出了世界上第一块集成电路。这一天，被视为集成电路的誕生日。就是这枚小小的芯片，开创了电子技术历史的新纪元。



罗伯特·诺伊斯  
英特尔创始人

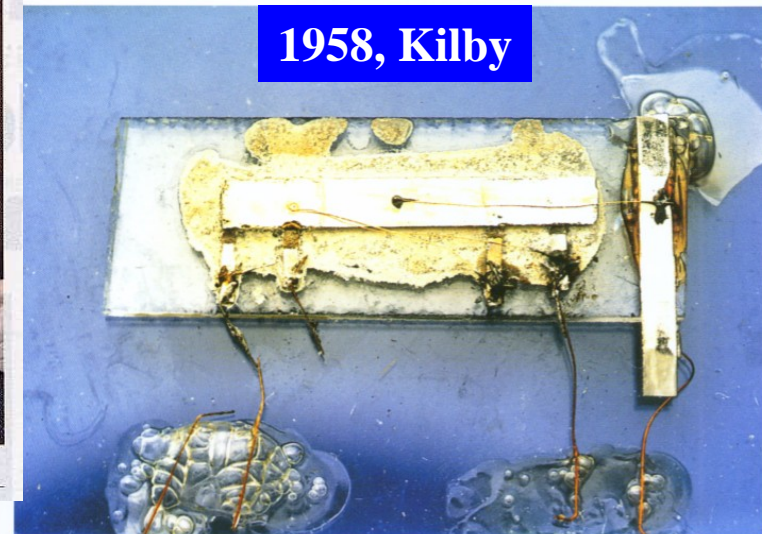
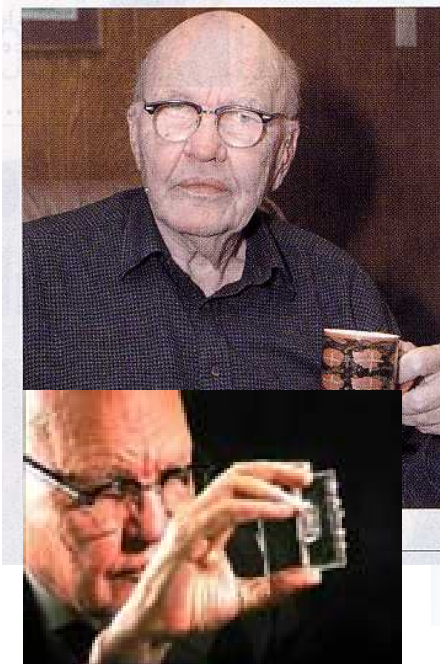

诺伊斯最大的成就是发明了集成电路。当基尔比在德州仪器用锗晶片研制集成电路时，诺伊斯和摩尔已把眼光直接盯住了硅晶片，因为硅的商业前景要远远超出锗。1959年2月，诺伊斯为“微型电路”申请了专利，但没有为他用平面处理技术制造的集成电路申请专利，直到同年7月才补全了这一手续。而此前德州仪器公司已宣布生产集成电路的产品，该公司的基尔比拥有第一个专利，但他的设计不实际，而诺伊斯则是第二个提出该专利的人。于是整个60年代，仙童和德仪相互控告，最后法庭将集成电路的发明专利授予了基尔比，而将关键的内部连接技术专利授予诺伊斯。

英特尔 (Intel) 公司起初名为 "摩尔-诺伊斯电子公司", Moore Noyce 听起来像 more noise (吵吵闹闹), 实在不雅。

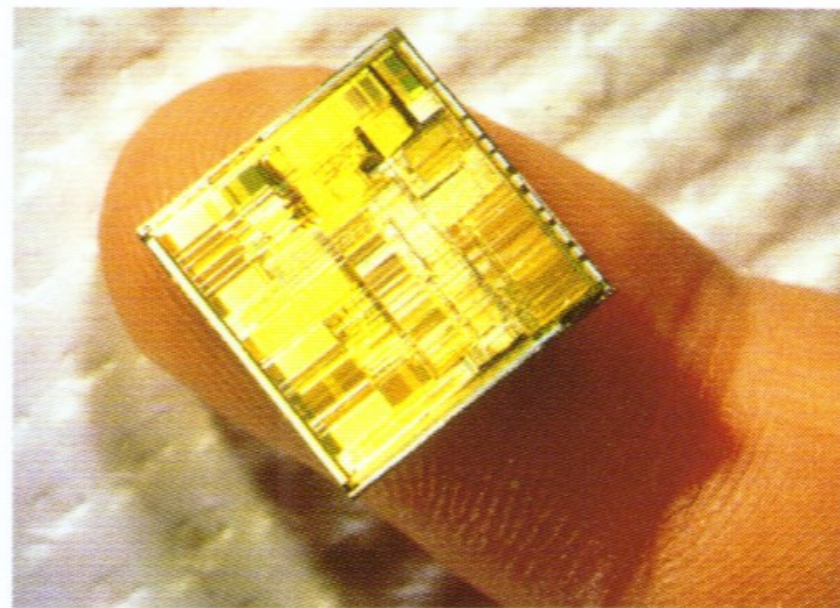

**1996, Intel**

电子作为信息的载体，自从人们发明了晶体管用来控制电子的流动以来，半导体材料和技术已经成为现代信息社会的基础。

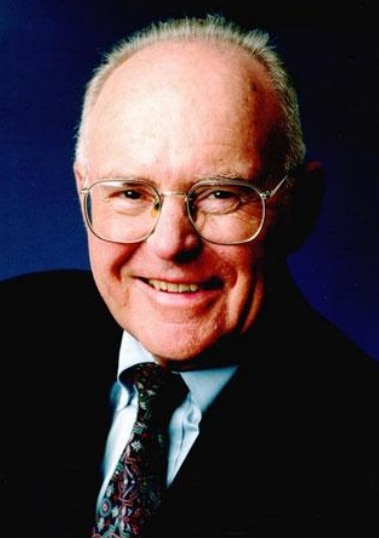

戈顿·摩尔

芯片制造厂商Intel公司的创始人之一

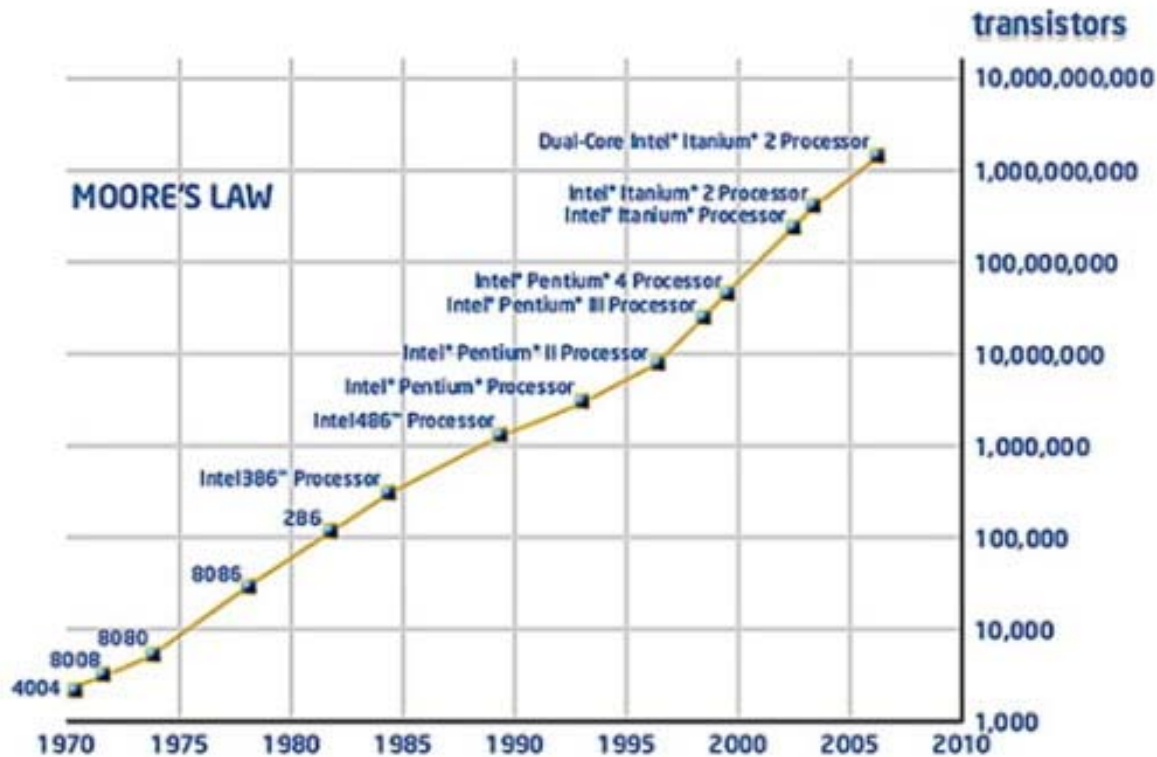

摩尔定律: 摩尔在1965年指出, 芯片中的晶体管和电阻器的数量每年会翻番; 1975年把"每年翻一番"改为"每两年翻一番"

专家预言, 在不久的将来, 硅器件的进一步发展会遇到巨大障碍!



- 利用电子作为信息载体进行信息传输、处理和显示等的一系列技术革命，奠定了当代信息社会的技术基础。
- 用光代替电子作为信息载体，它在速度、信息载荷量、能耗方面有内禀的优势。
- 人工微结构材料通过对光子、声子能带结构进行裁剪，实现对光子、声子的强度、频率、位相、偏振和传播方向进行操纵和控制。

- Photonic Crystal
- Left-handed Material
- Cloaking
- QPM Material

# Thousand years ago, we built "fences"

...to control animals !



Not far back, we made "wires" and "integrated circuits"

...to control the flow of electrons

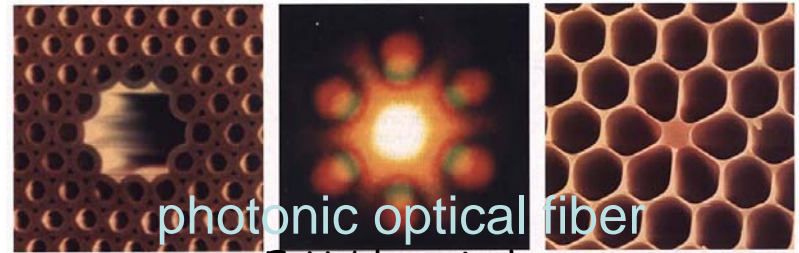

photonic optical fiber  
E. Yablonovitch,  
*Scientific American* 285, 47-55 (2001)

In the new century, we design photonic band gap materials "Photonic Crystals"

...to control the flow of light (photons).

Integrated optical circuits and all-optical computers

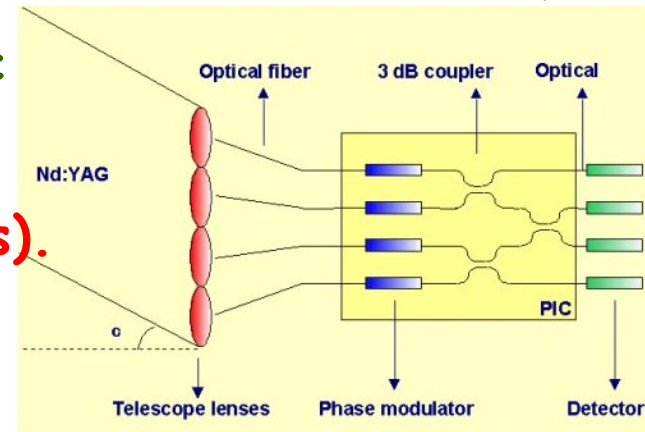

Figure 1: Functional layout

Photonic Integrated Circuits for Optical Phase Control  
ETH Zürich (Switzerland)  
2006



# 光子晶体

光子晶体：  
介电材料周期  
排列的人工结构

Yablonovitch

John

1987年提出



光子带隙材料：  
用控制电子的方式来控制  
光子（电磁波）

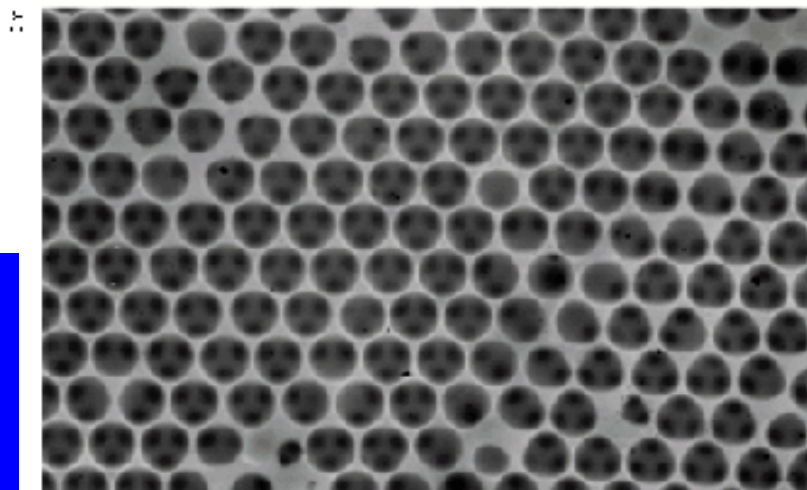
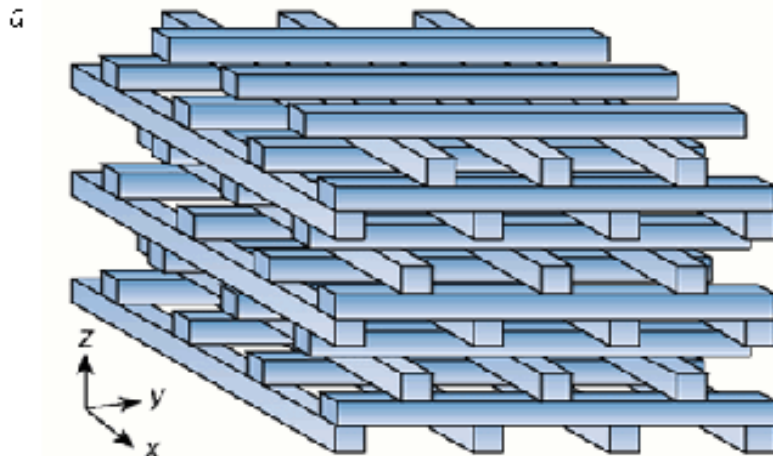

# Photonic crystal

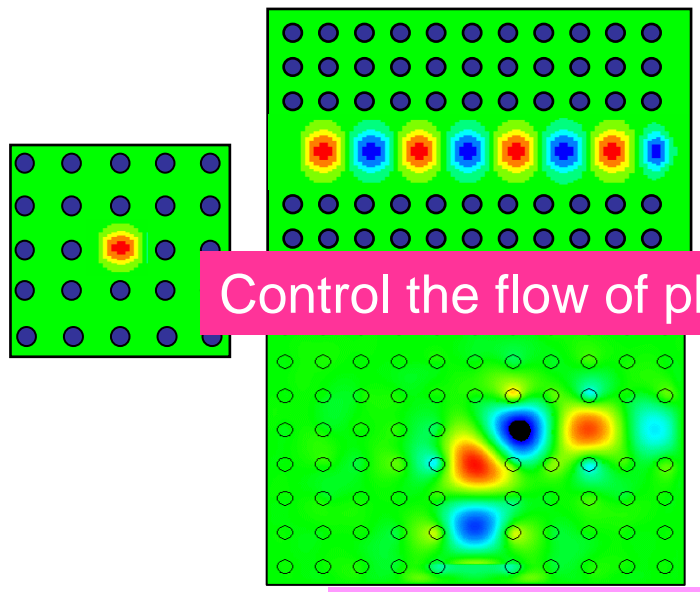
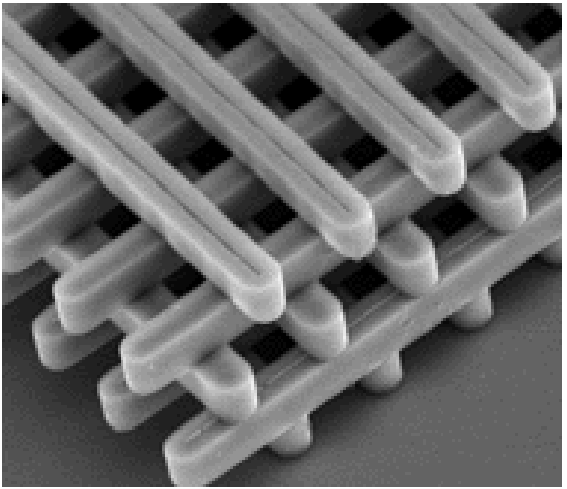
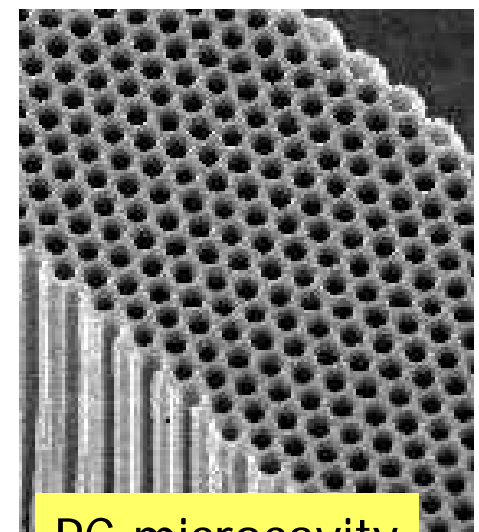
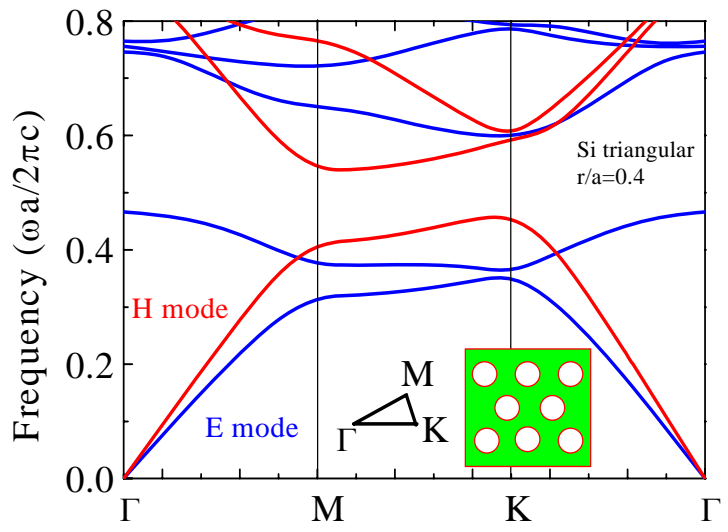
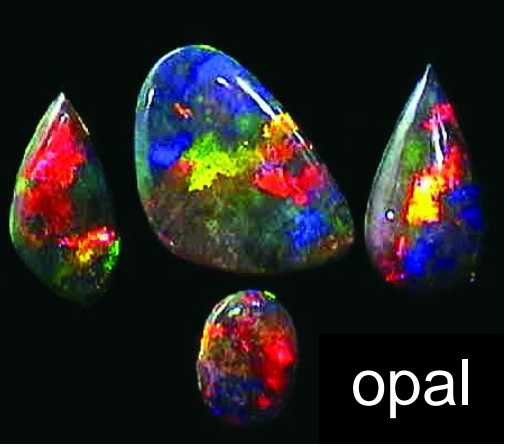

PC microcavity  
PC waveguide  
PC ...



# Photonic Band Gap Materials

## Contemporary fabrication methods:

### Artificial Opals

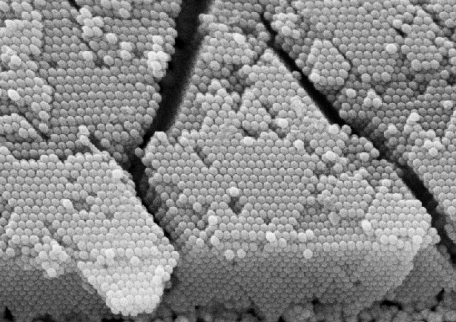

Y. Jiang, et al., J. of Phys. Condens. Mat. **15**, 5871-5879 (2003). (HKUST)

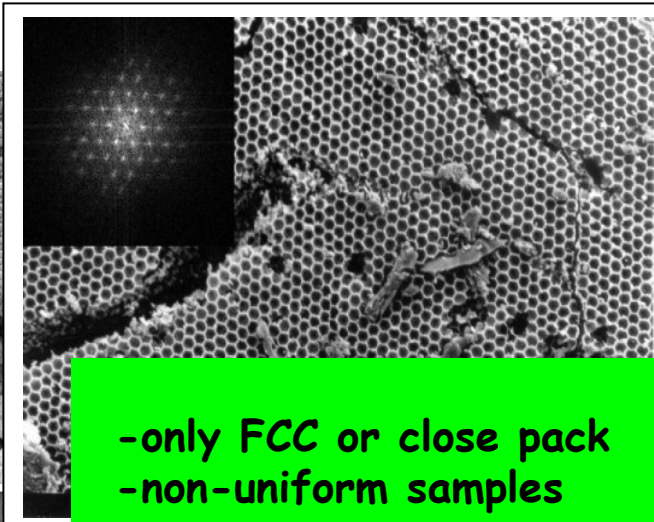

-only FCC or close pack  
-non-uniform samples

### Layer-by-layer Lithography

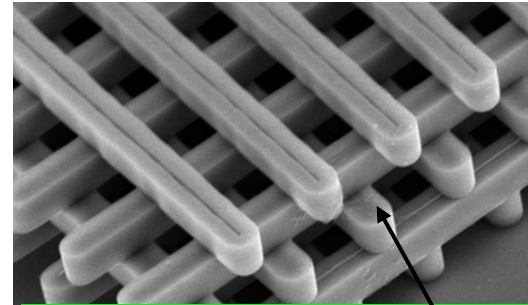

-few layers  
-very expensive

### Nano-robotic Manipulation

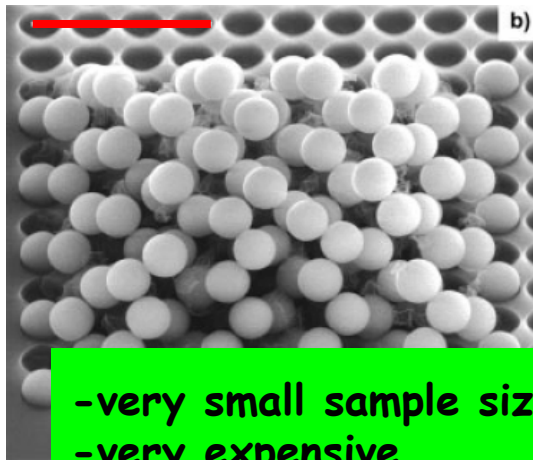

-very small sample size  
-very expensive  
-long time

### Direct Laser Writing

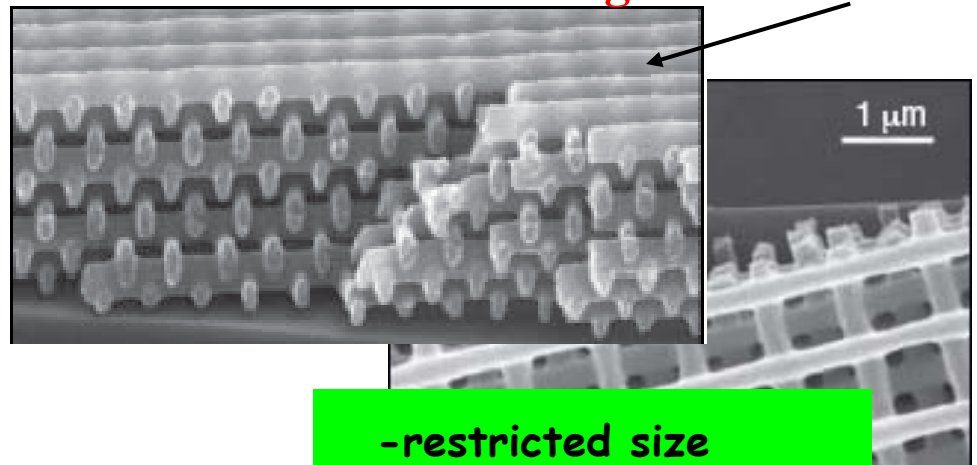

-restricted size  
-relatively expensive  
-long time

### Woodpiles

# 复杂色散关系—奇特的光子传播行为

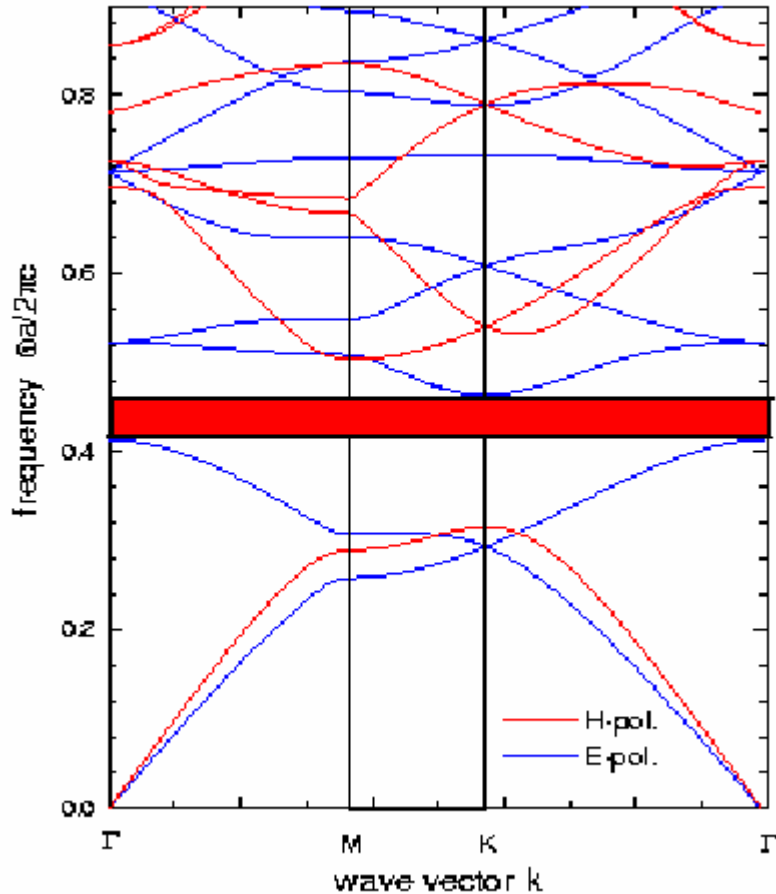

反常折射:

- 接近于零的折射率  
(大于零)
- 巨大折射率
- 负折射率
- 折射角对入射角 (或  
频率) 敏感的折射现象

➤ 相速度  $V_p \sim \omega(k)/k$

➤ 群速度  $V_g \sim \partial\omega/\partial k$

# 声子晶体负折射成像

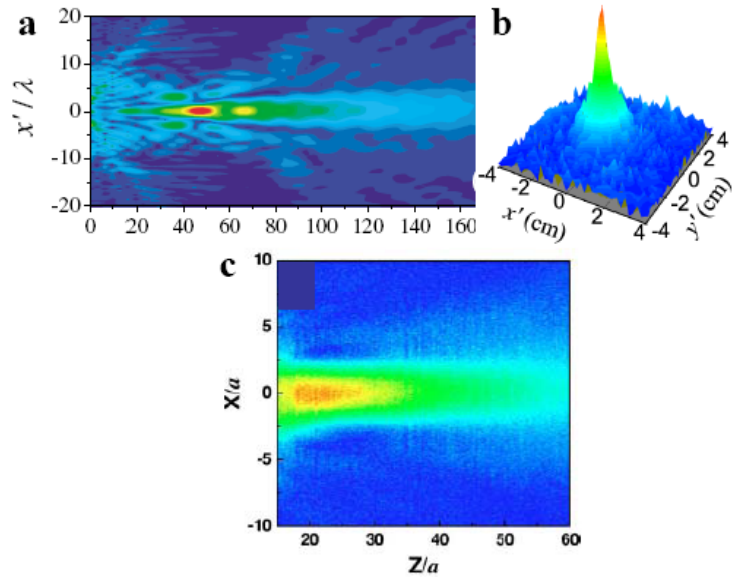

当正常介质与负折射介质的等频圆（二维）或等频球（三维）等大小时，方可成像，否则成变形的像

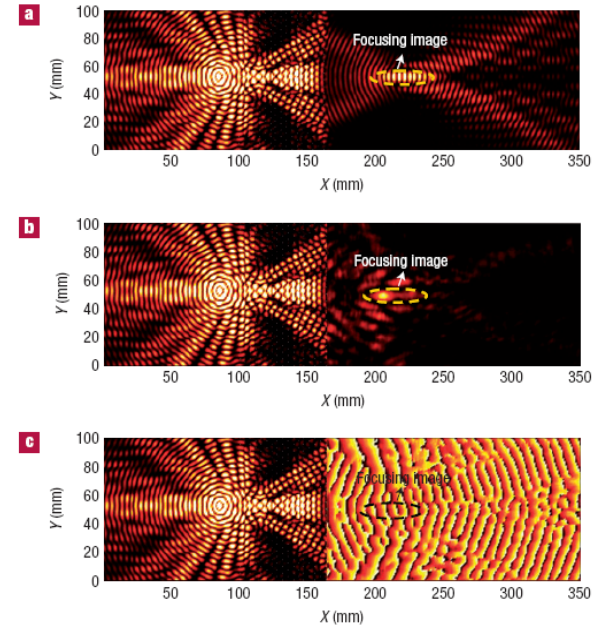

声子晶体由于负折射可以利用负折射来实现透射聚焦成像

Phys. Rev. Lett. 93, 024301 (2004).  
Phys. Rev. B 71, 054302 (2005).  
Phys. Rev. B 73, 054302 (2006)  
Appl. Phys. Lett. 85, 341 (2004)  
Nature Mater. 6,744 (2007)

# Left-handed material

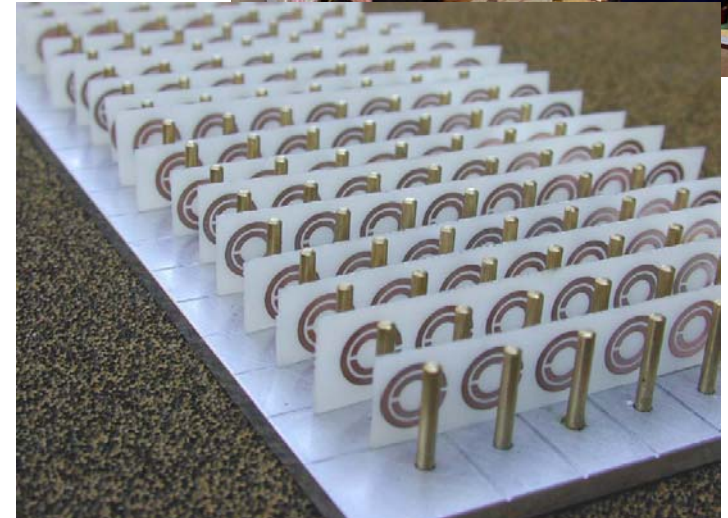
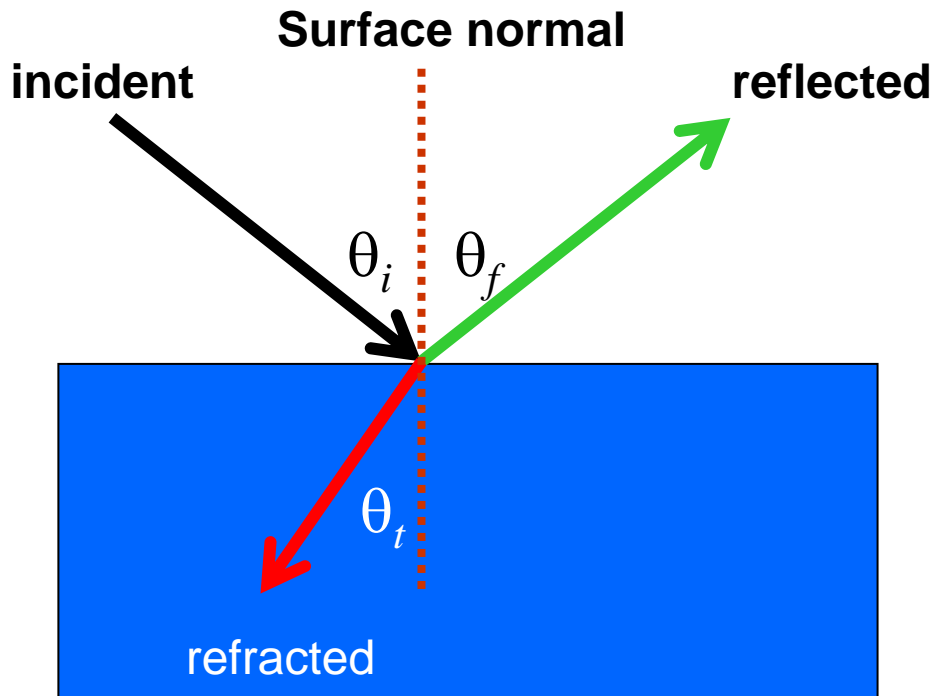

A LHM would have dramatically different propagation characteristics stemming from the sign change of the group velocity, including reversal of both the Doppler shift and Cherenkov radiation, anomalous refraction, and even reversal of radiation pressure to radiation tension.

A composite medium, based on a periodic array of interspaced conducting nonmagnetic split ring resonators and continuous wires, that exhibits a frequency region in the microwave regime with simultaneously negative values of effective permeability and permittivity.



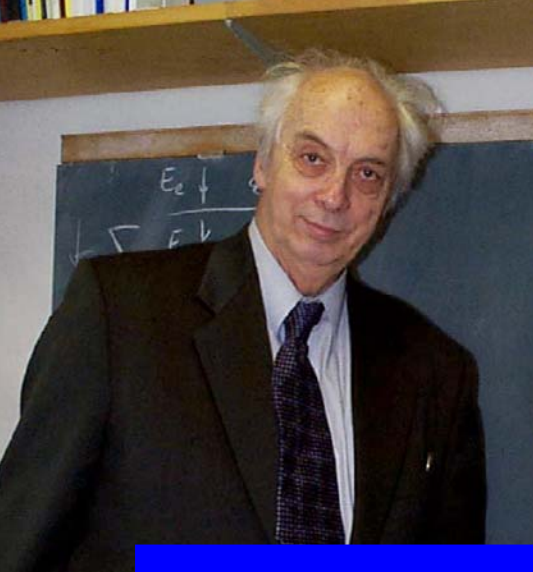

## Left-Handed Materials → Negative Refractive Index

Electromagnetic waves will only propagate in a medium that has a real index of refraction,  $n_{\text{eff}}(\omega) = \sqrt{\varepsilon_{\text{eff}}(\omega)\mu_{\text{eff}}(\omega)}$ . If either  $\varepsilon_{\text{eff}}(\omega)$  or  $\mu_{\text{eff}}(\omega)$  is negative, then  $n_{\text{eff}}(\omega)$  is imaginary, and there will be no transmission through a thick sample. If, however, both  $\varepsilon_{\text{eff}}(\omega)$  and  $\mu_{\text{eff}}(\omega)$  are less than zero, electromagnetic waves will propagate through the medium, but the negative root must be chosen for  $n_{\text{eff}}(\omega)$ , and the group and phase velocities will be antiparallel.

# Metamaterial for EM Cloaking

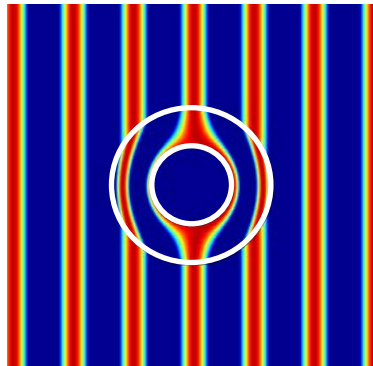
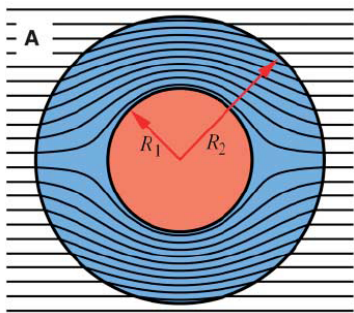
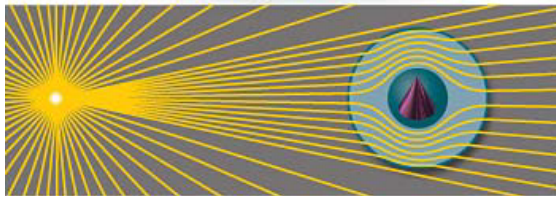
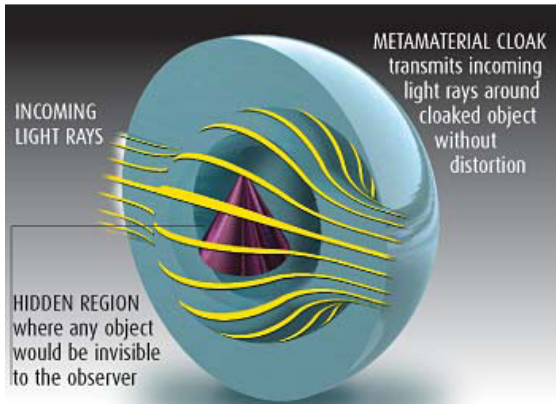

- Pendry *Science* 312, 1780 (2006).
- U.Leonhardt *Science* 312, 1777(2006).

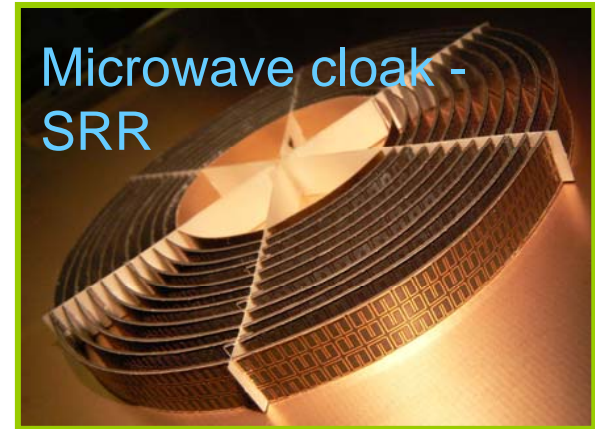

- Smith & Pendry, *Science* 314, 977 (2006)

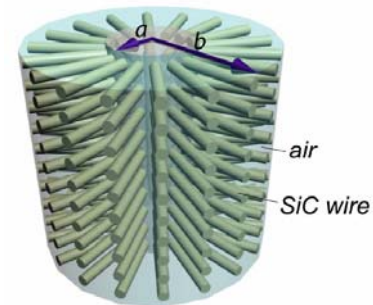
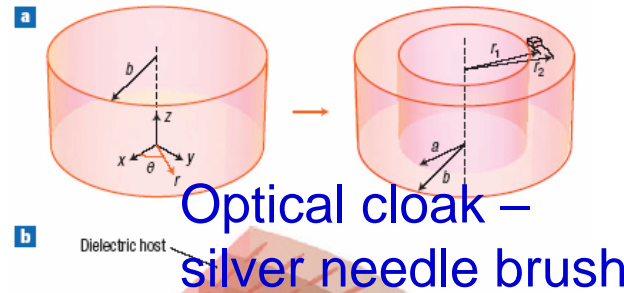

- *Opt. Express*, 16, 2008.

- *Nat. Photonics*, 1, 224(2007).

# Ferroelectric domain structures

nonlinear optical, piezoelectric, electrooptic

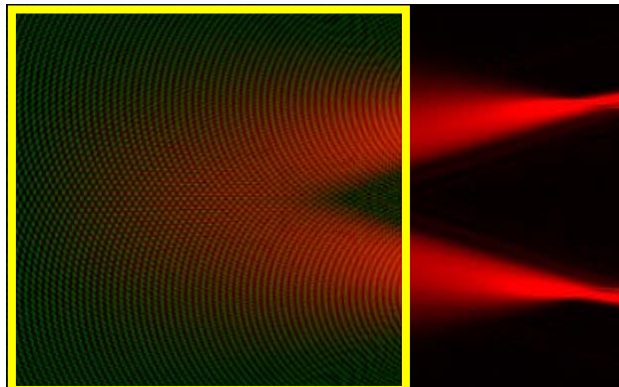
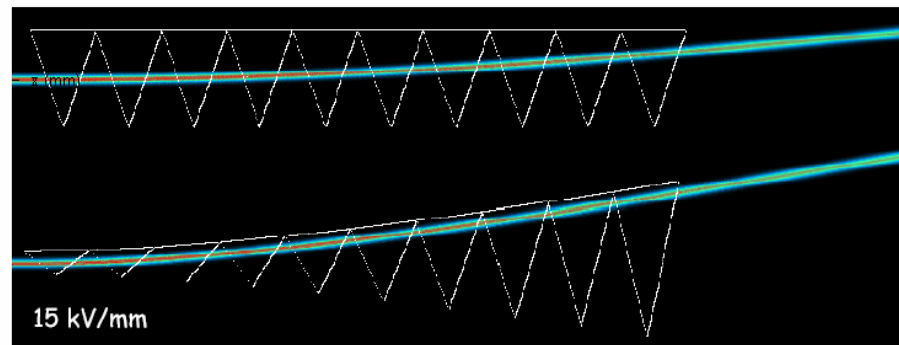
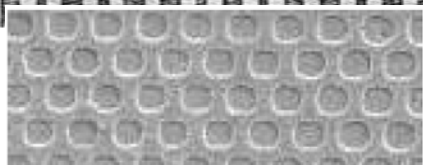
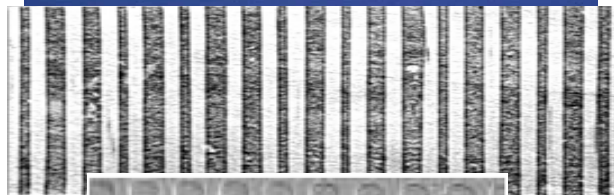
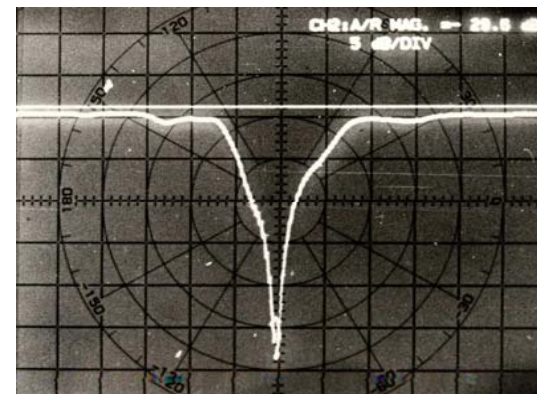
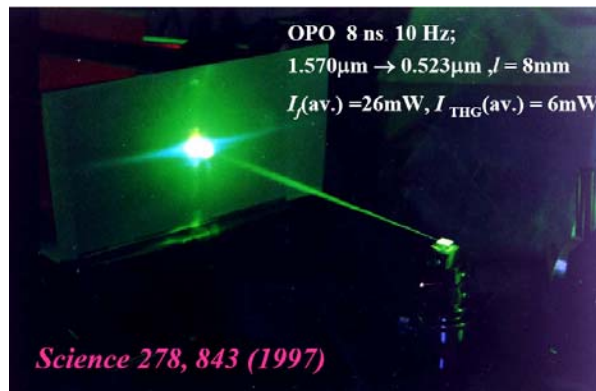

...Researchers no longer just study the rich variety of materials provided by nature but have rather become creative designers who tailor optical properties at will, leading to qualitatively new and unprecedented behavior....

原子在三维空间的规则排列

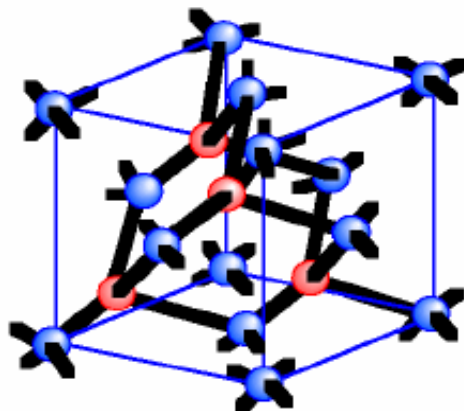

金刚石结构

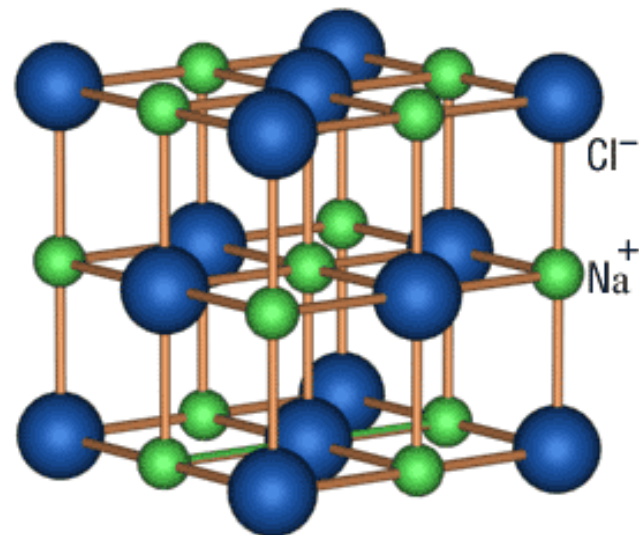

氯化钠结构 (NaCl)



- Photonic Crystal
- Left-handed Material
- Cloaking
- QPM Material

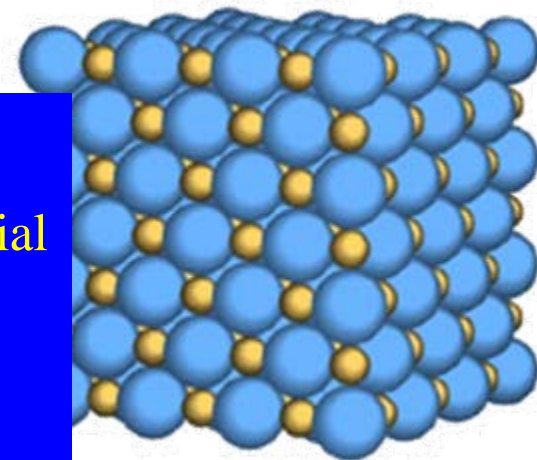

In a sense, every material is a composite, even if the individual ingredients consist of atoms and molecules. .... it is only a small step to replace the atoms of the original concept with structure on a larger scale.



朝韩停止“三八线宣传战”

二维“声子晶体”



“原子”在平衡位置附近的热振动

# Content

- Introduction
- Piezoelectric superlattice
  - Piezoelectric transducer
  - Polariton: Superlattice vibration
- Polariton in a plasmonic crystal
- Conclusions

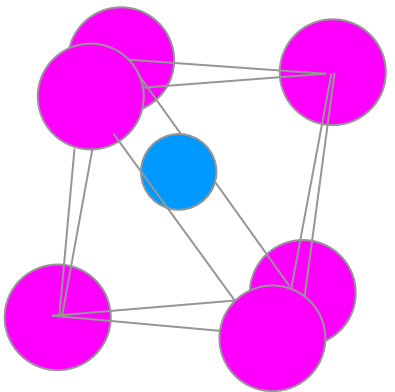
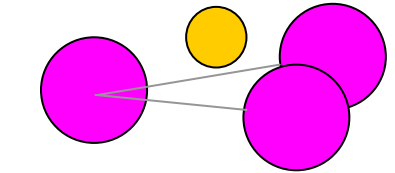
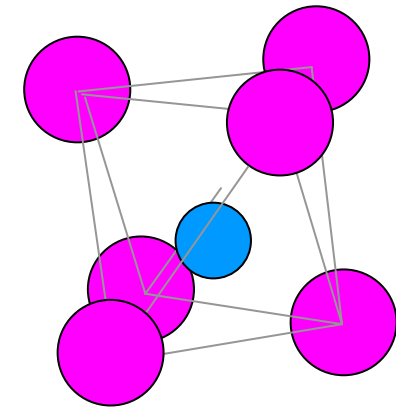
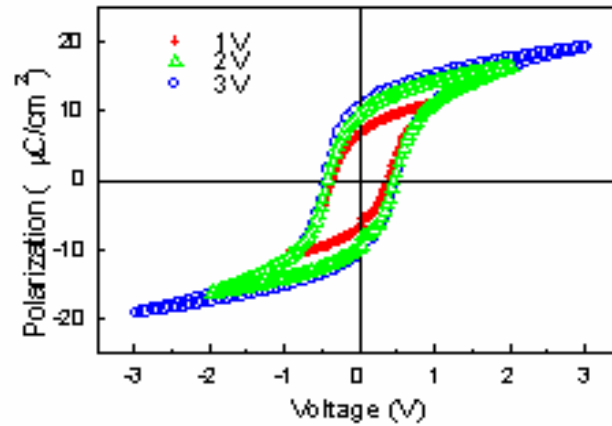
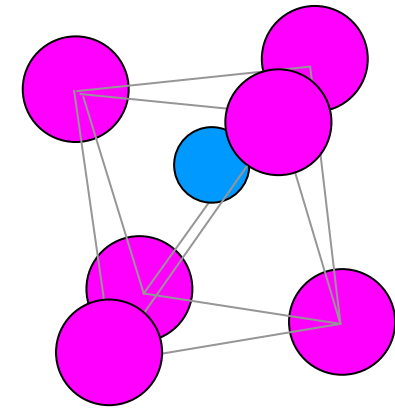

A ferroelectric crystal is a material the direction of whose spontaneous polarization can be changed by an external electric field.

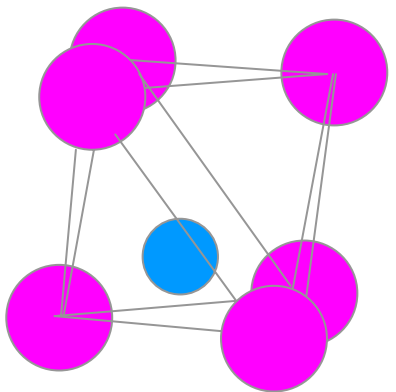
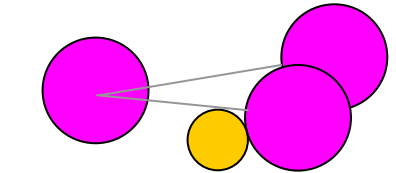

*LiNbO<sub>3</sub>*



# Patterned Ferroelectric Domain Structures

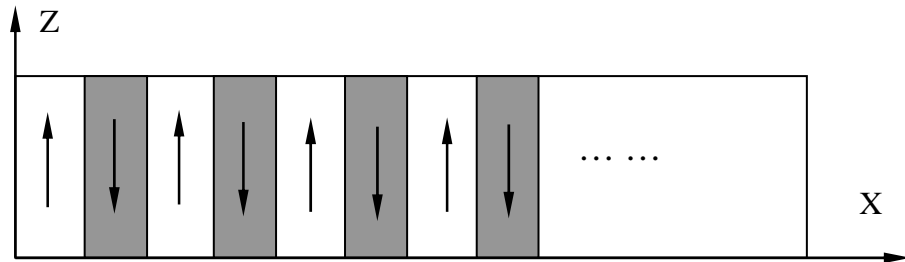

(a)

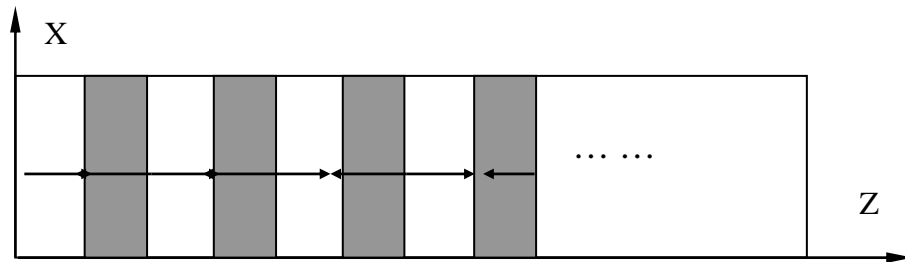

(b)

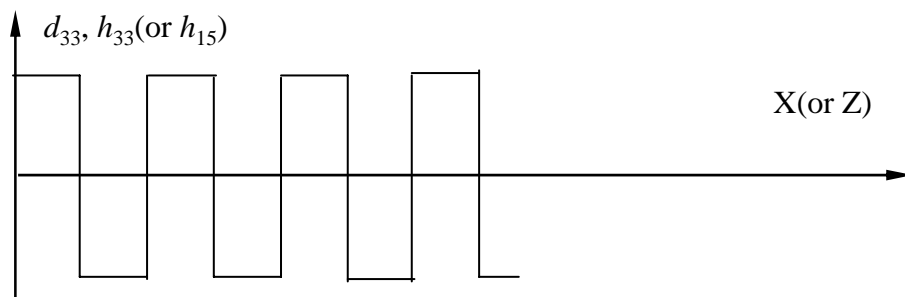

(c)

Physical properties modulated:  
Second-order nonlinear optical,  
piezoelectric and electrooptic  
coefficients

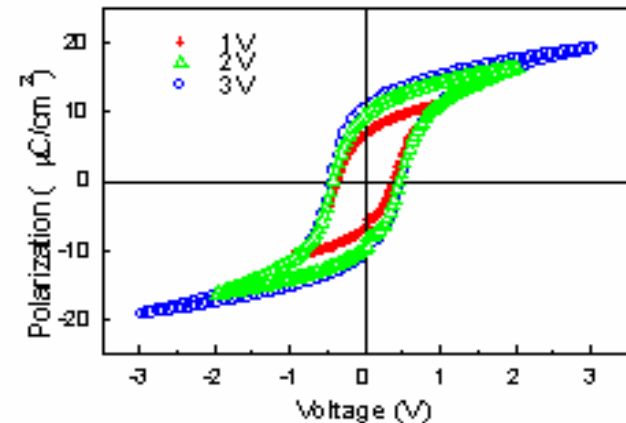

A ferroelectric crystal is a material the direction of whose spontaneous polarization can be changed by an external electric field.

# How to prepare a domain structure?

**Growth striation method**

**Room temperature poling**

Direct electron beam writing

Atomic force microscopy

Scanning probe microscopy

focused ion beam

# Growth Striation Method

Temperature field

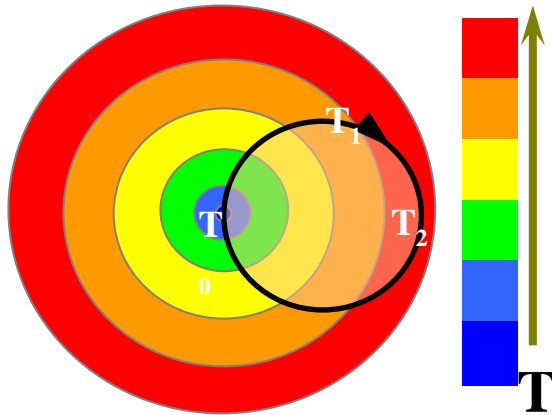

Periodic temperature fluctuation →  
periodic impurity concentration →  
periodic space charge field → periodic  
ferroelectric domain

First realized by Feng and  
Ming et al. in LN by the  
growth striation method

Growth Striation Method

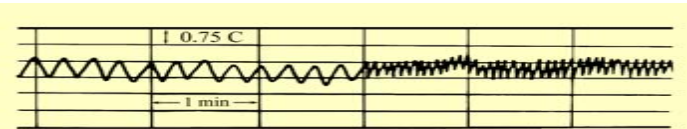
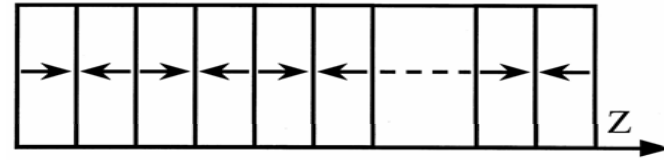

T@SL interface



Temperature fluctuations measured  
on the solid-liquid interface and the  
corresponding surface rotational  
growth striations in a LN crystal

# Room temperature poling

The room temperature poling technique: attracted much attention due to its capability to fabricate, when combined with photolithography, domain structures with any pre-designed patterns.

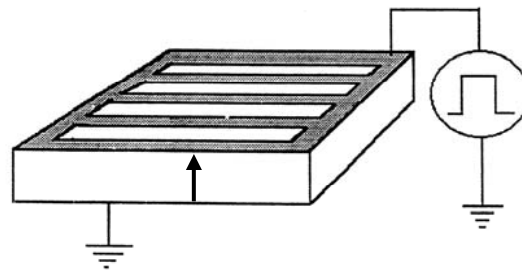
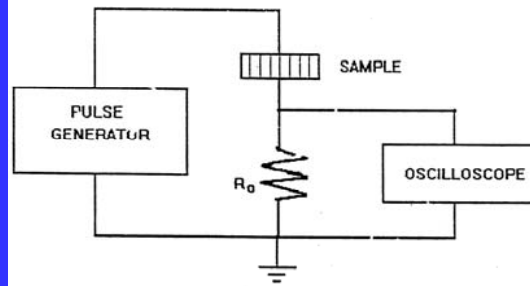

Schematic setup for domain engineering and optical micrographs of some samples with modulated ferroelectric domains

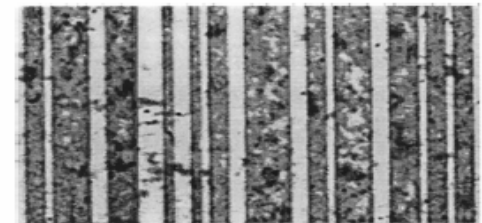
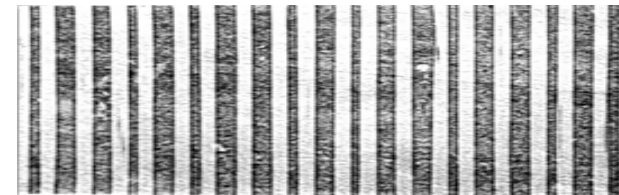

# Physics of Dielectric: polarization

1. Electronic: arises from the displacement of the electron shell relative to a nucleus by E field
2. Ionic: comes from the displacement of a charged ion with respect to other ions by E field
3. Piezoelectric material: polarization due to strain
4. Orientational polarization

$$P \propto \chi^{(1)}E + \chi^{(2)}E^2 + \chi^{(3)}E^3 + \dots$$

QPM: Nonlinear optical effect

The light field is a harmonic function, such as  $E \cos(\omega t)$ . Trigonometric identities allow a power of a harmonic function, like  $\cos^2(\omega t)$ , to be converted to terms like  $\cos(2\omega t)$ . The nonlinear terms in the polarization can then be grouped as

$$P \propto \dots + \chi^{(2)}E^2 \cos(2\omega t) + \chi^{(3)}E^3 \cos(3\omega t) + \dots \quad [2]$$

$$T_1 =$$

Piezoelectric effect: Acoustic transducer & Polariton

$$P_2 = -e_{22}(x)S_1 + \epsilon_0(\epsilon_{11}^S - 1)E_2$$

# Content

- Introduction
- Piezoelectric superlattice
  - Piezoelectric transducer
  - Polariton: Superlattice vibration
- Polariton in a plasmonic crystal
- Conclusions

## Piezoelectric effect

A piezoelectric material is a material that becomes electrically polarized when it is strained or that becomes strained when placed in an electric field.

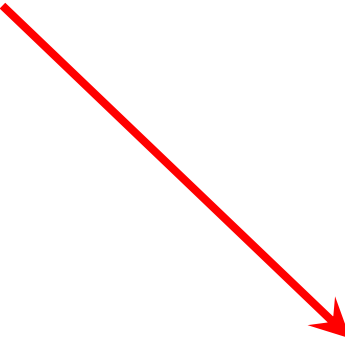

## Piezoelectric effect

that becomes strained when placed in an electric field.

# Piezoelectric transducer

$$\frac{\partial^2 u_3}{\partial t^2} - \left(\frac{C_{33}^D}{\rho}\right) \frac{\partial^2 u_3}{\partial z^2} = D_3 \frac{\partial h_{33}}{\partial z}$$

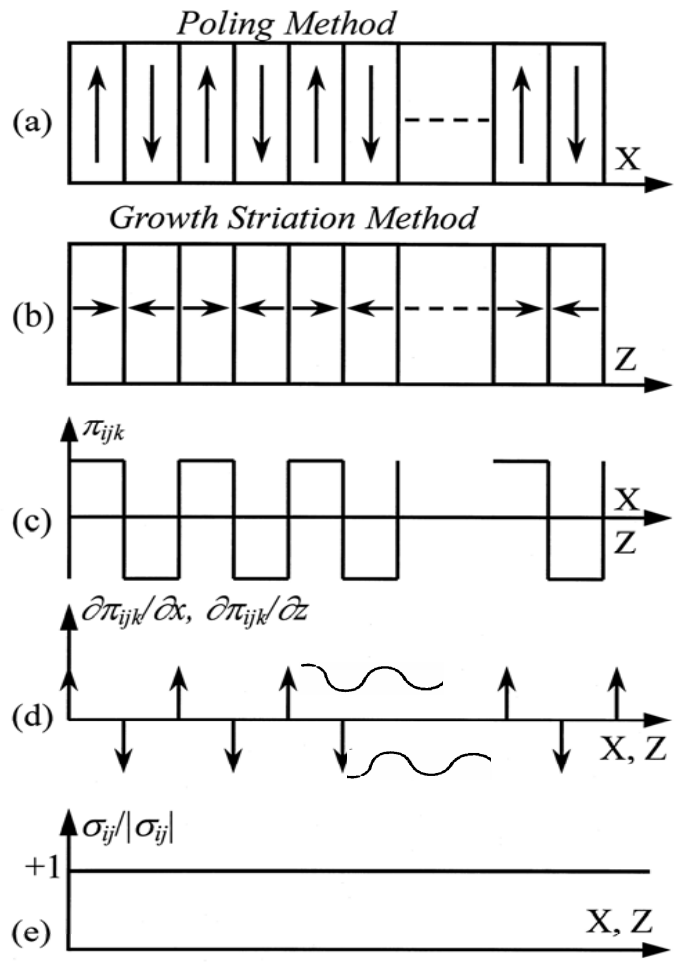

Domain walls

δ sources

Elastic waves

Constructive interference

Resonance

Physical basis for the ultrasonic excitation

**Resonance freq. depends on structure's periodicity, not on its total thickness.**



# Piezoelectric transducer

**Crossed-field Scheme:**  
Electric field and propagation  
vector perpendicular

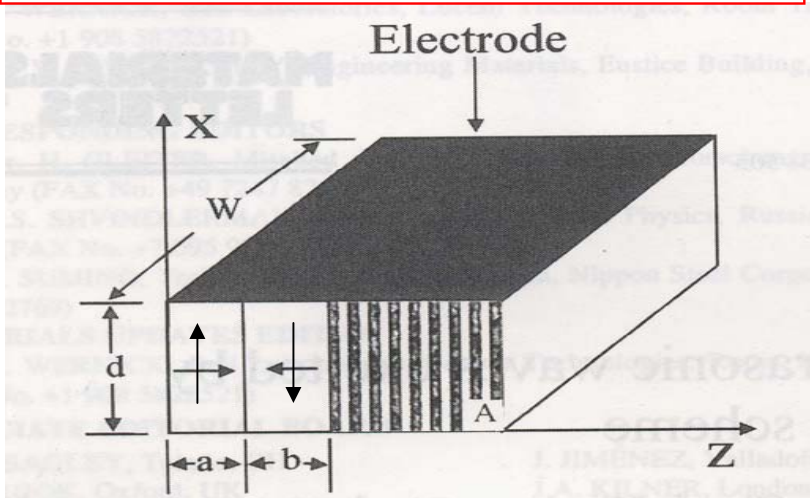

**In-line field Scheme:**  
Acoustic propagation vector  
parallel to the applied electric field

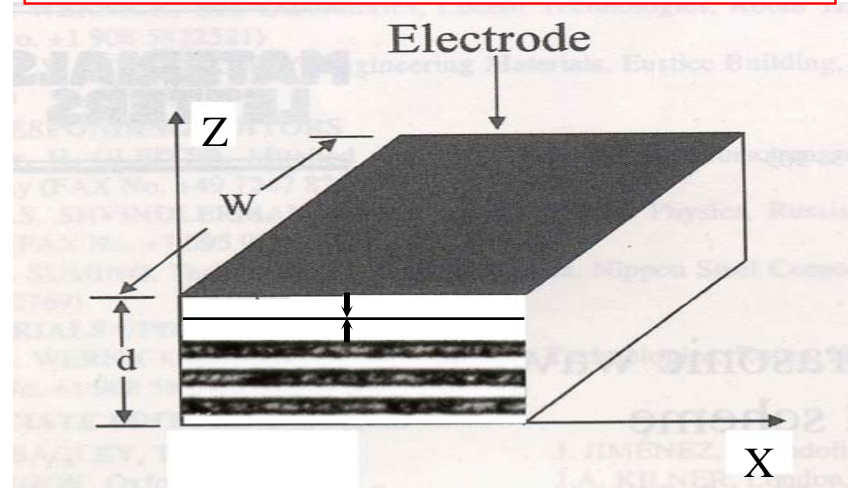

High Frequency(GHz)

Resonators  
Acoustic filters  
Transducers

**Resonator**

$$T(z=0)=T(z=N(a+b))=0$$

**Transducer**

$$T(z=0)=T(z \rightarrow \infty))=0$$

# Piezoelectric transducer

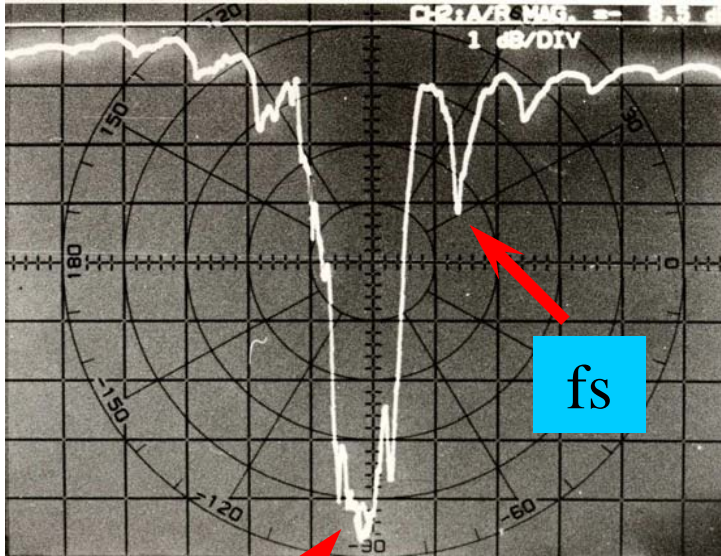

S: Satellite-like

$$f_{\text{main}} = v/(a+b)$$

$$(fs)^m = mf_{\text{main}}/2N$$

$$m = \pm 1, \pm 3, \pm 5 \dots$$

N: Periods

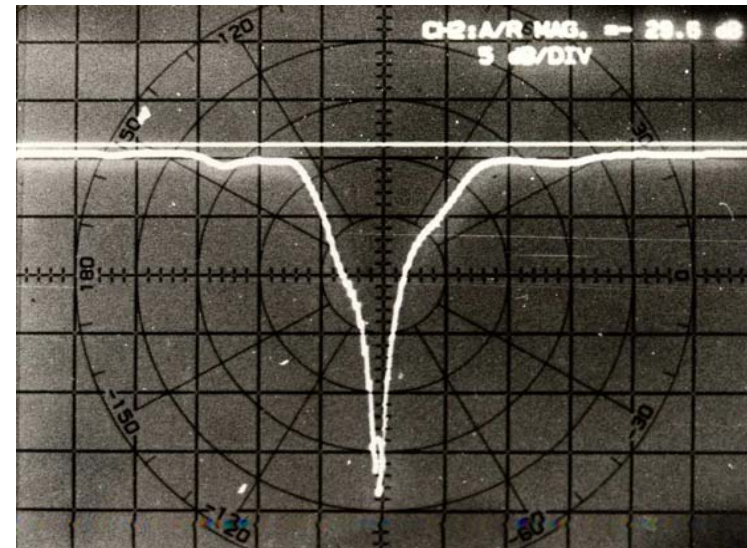

# Acoustooptic Interaction

Bragg Angle

$$\sin \theta_B = \lambda_{Light} / (2n\Lambda_{Acoust})$$

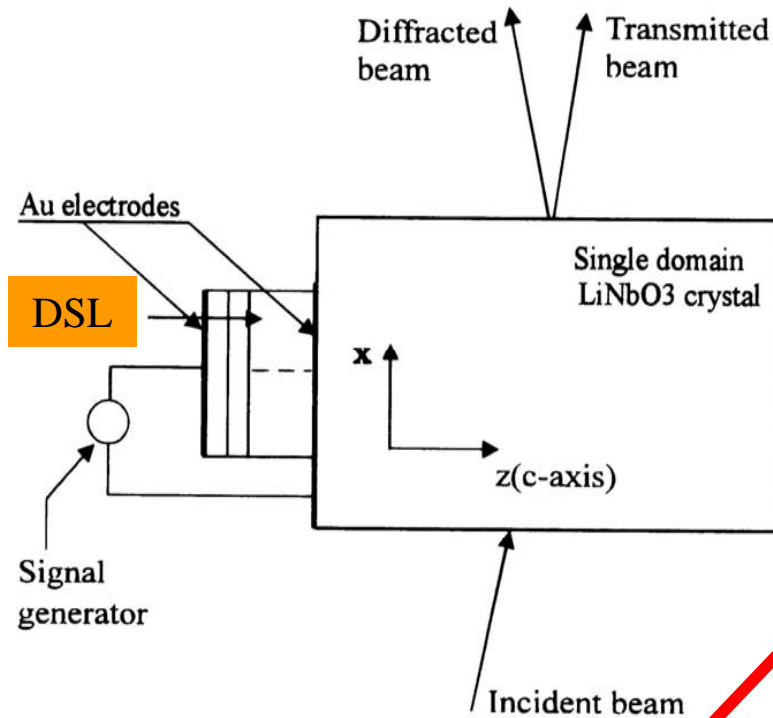

Normal incidence

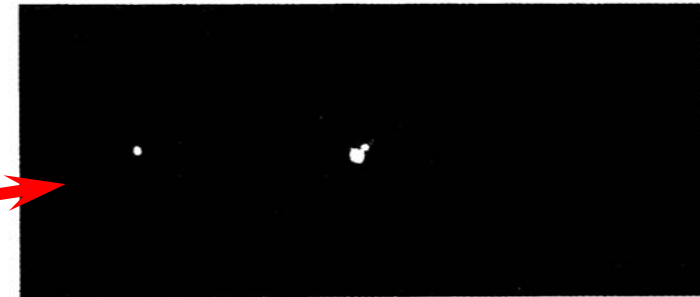
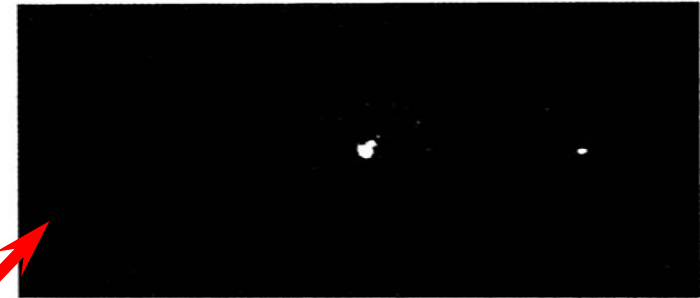
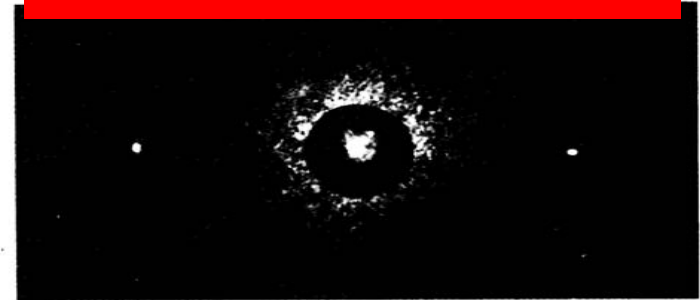

Incident at Bragg angle

# Content

- Introduction
- Piezoelectric superlattice  
Piezoelectric transducer  
**Polariton: Superlattice vibration**
- Polariton in a plasmonic crystal
- Conclusions

## Piezoelectric effect

A piezoelectric material is a material that becomes electrically polarized when it is strained or that becomes strained when placed in an electric field.

In a piezoelectric material, the superlattice vibrations will induce electrical polarization. The laterally electrical polarization in turn will emit EM waves that interfere with the original EM wave. In such a case, lattice vibration and the EM wave will be coupled strongly.

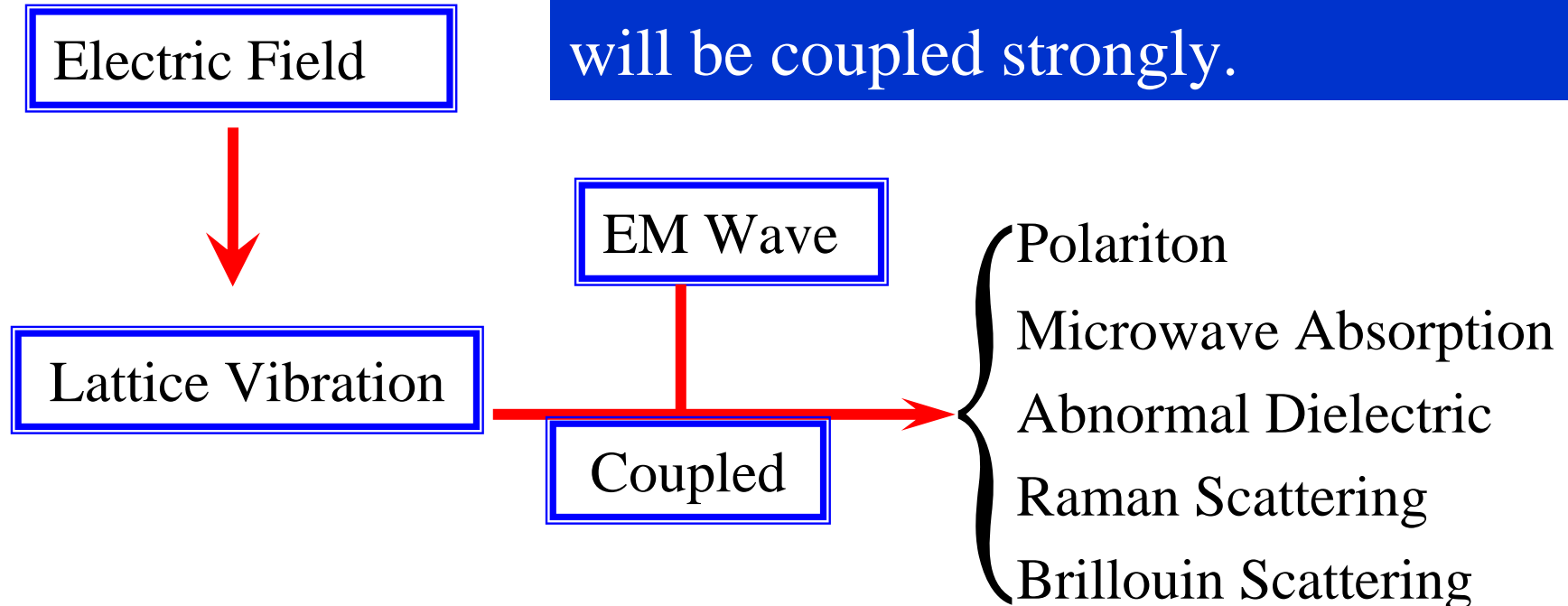

# Polariton

## Polariton in piezoelectric superlattices

EM wave coupled strongly with

- **Transverse superlattice vibration**

**Science 284, 1822(1999)**

- **Longitudinal superlattice vibration**

**PRL90, 053903 (2003) (Theoretical)**

**PRB 69, 085118 (2004) (Exp.: periodic)**

**APL 85, 3531 (2004) (Exp.: Quasiperiodic)**

- **Piezoelectric-induced coupling of polaritons**

**PRL 94, 117401 (2005) (Theoretical)**

# Polariton

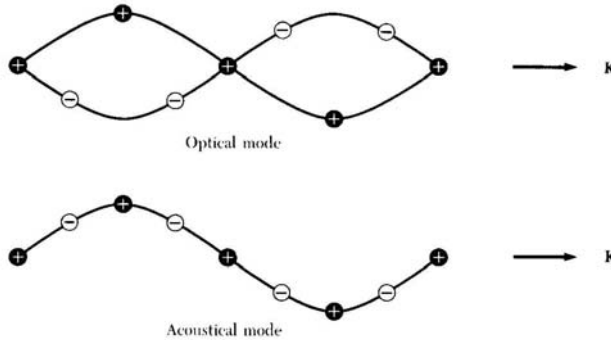

**Figure 10** Transverse optical and transverse acoustical waves in a diatomic linear lattice, illustrated by the particle displacements for the two modes at the same wavelength.

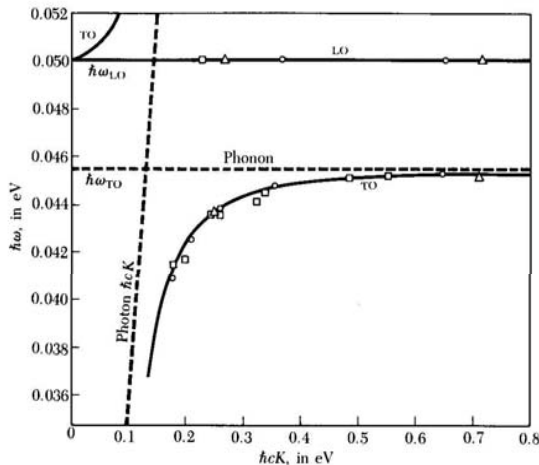

**Figure 11** A plot of the observed energies and wavevectors of the polaritons and of the LO phonons in GaP. The theoretical dispersion curves are shown by the solid lines. The dispersion curves for the uncoupled phonons and photons are shown by the short, dashed lines. (After C. H. Henry and J. J. Hopfield.)

For lattice vibrations belonging to the transverse optical branches, the atoms carrying opposite charges vibrate against each other. This type of vibration can be excited by the electric field of a light wave.

# Polariton

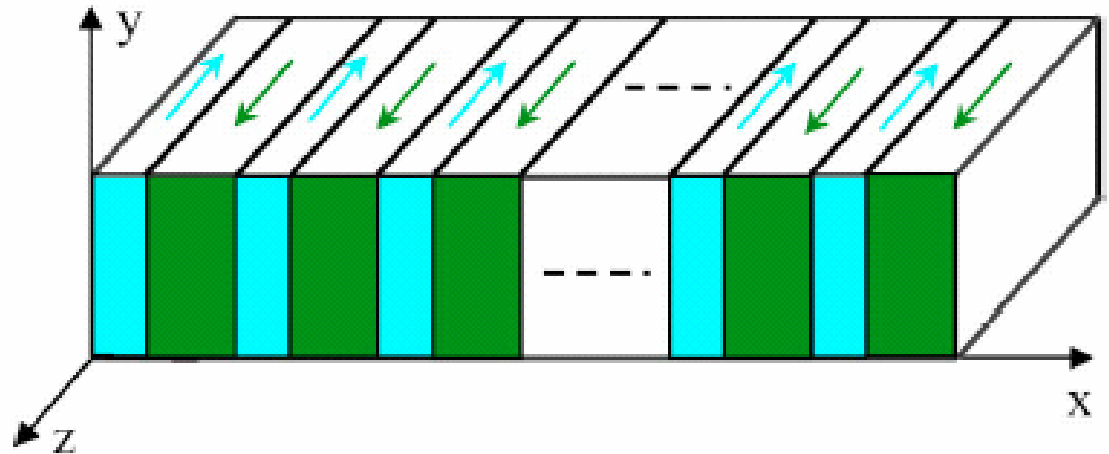
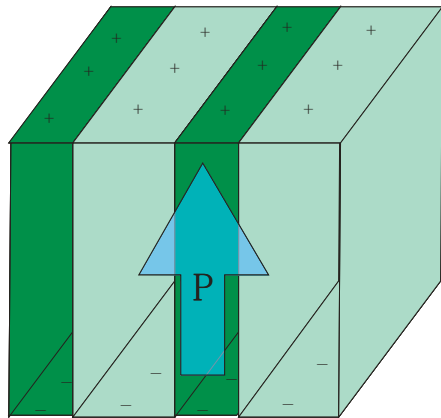
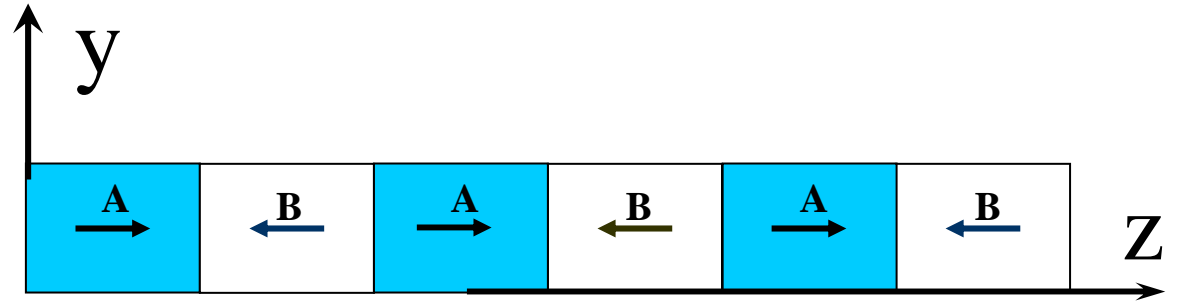
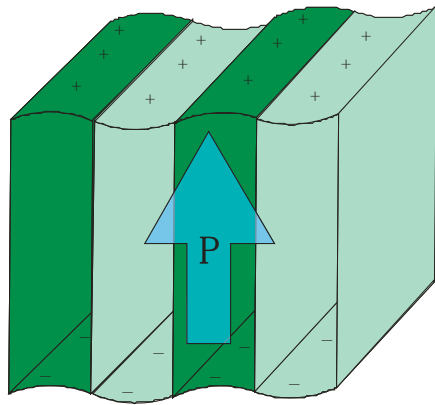

**It is the transverse polarization  $P_2$  that couples strongly with the EM wave. Whereas whether or not the superlattice vibration is of transversal or longitudinal is not relevant.**



# Piezoelectric equations

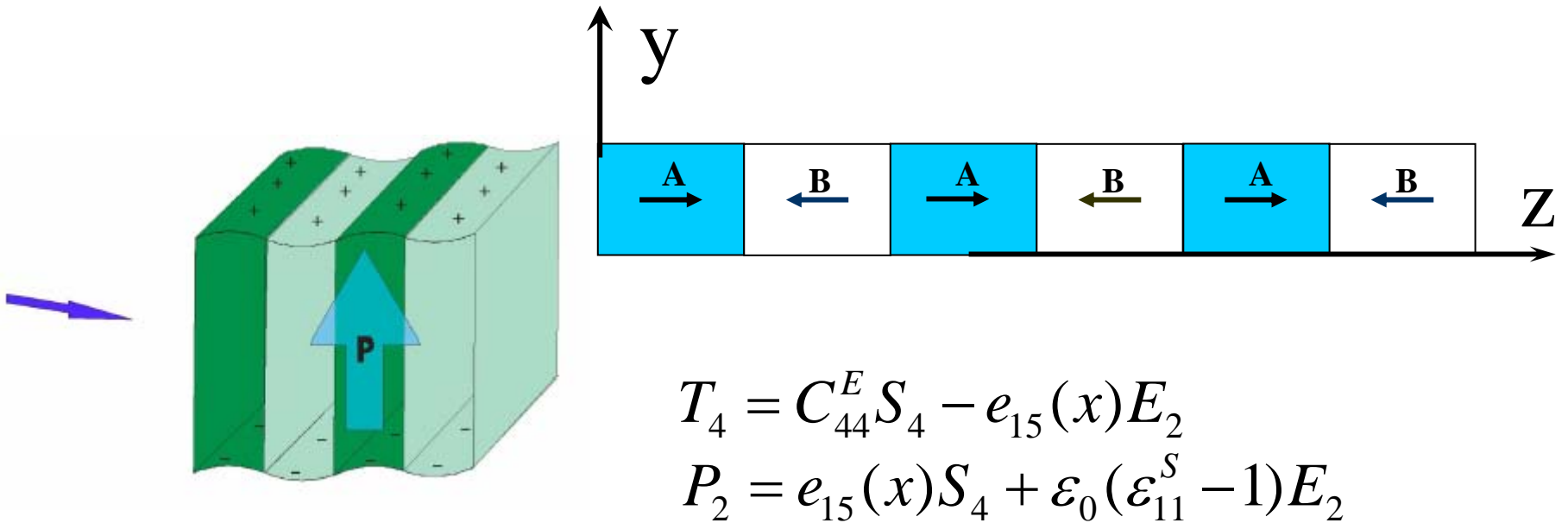

A transverse acoustic wave propagating along the z-axis will be excited.

For this configuration, EM wave couples strongly with transverse superlattice vibration.

# Piezoelectric equations

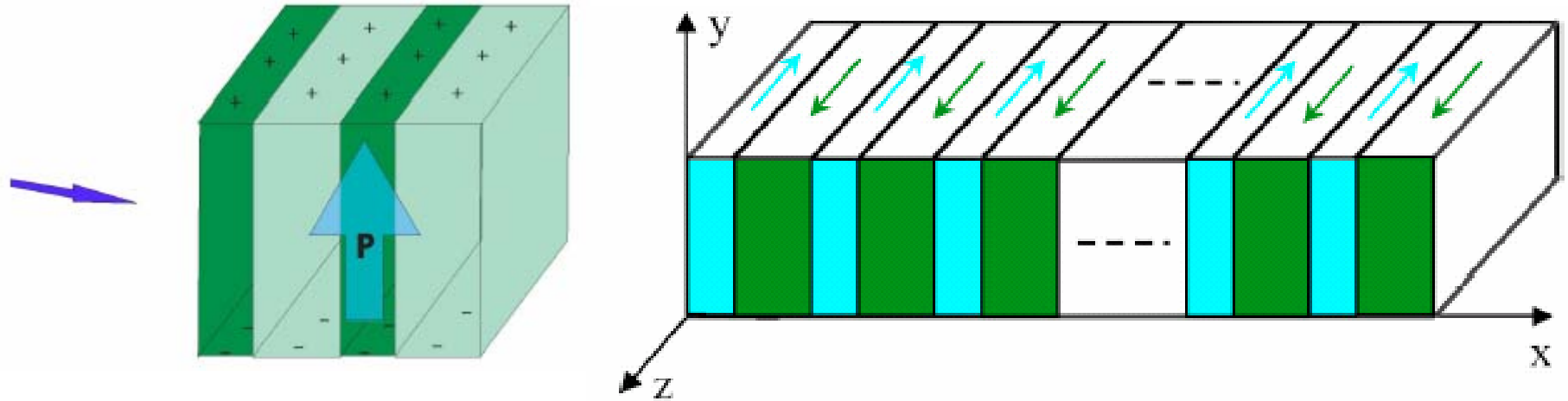

$$T_1 = C_{11}^E S_1 + e_{22}(x) E_2$$

$$P_2 = -e_{22}(x) S_1 + \epsilon_0 (\epsilon_{11}^S - 1) E_2$$

For this configuration, a longitudinal superlattice vibration propagating along the  $x$ -axis will be excited.

# Polariton

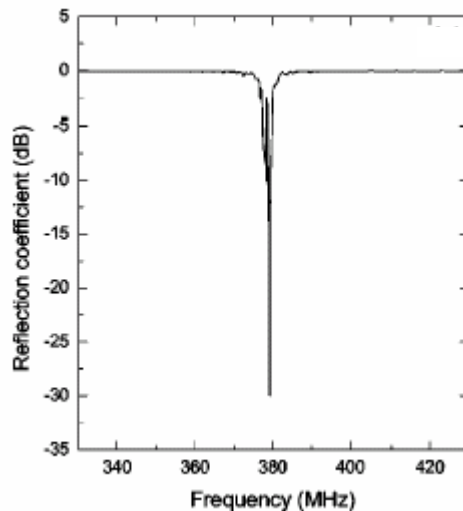
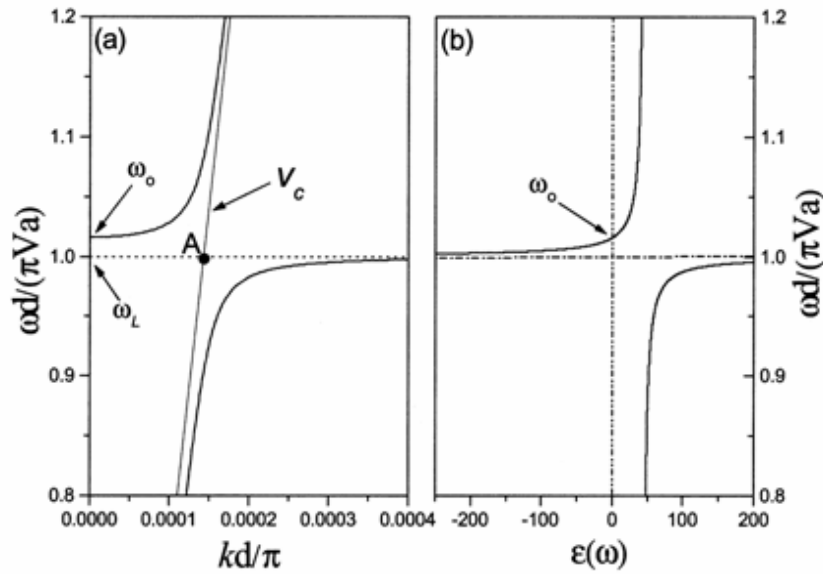

- At resonance, both energy conservation and momentum conservation are fulfilled.
- The photon-phonon coupling entirely changes the character of the propagation.
- Strong coupling induces a gap where EM waves are highly reflected.

## 从压电方程到黄昆方程

$$\begin{aligned} \ddot{W}_2 &= b_{11} W_2 + b_{12} E_2 \\ P_2 &= b_{21} W_2 + b_{22} E_2 \end{aligned}$$

$$b_{11} = -\omega_m^2, \quad b_{22} = \varepsilon_0 (\varepsilon_{11}^S - 1),$$

$$b_{12} = b_{21} = \frac{4e_{15}}{\Lambda} \sqrt{\frac{2}{\rho}} \sin(mD\pi)$$

$$W_2 = i\sqrt{2\rho} e^{iG_m d/2} U_2$$

# Polariton: Quasiperiodic structure

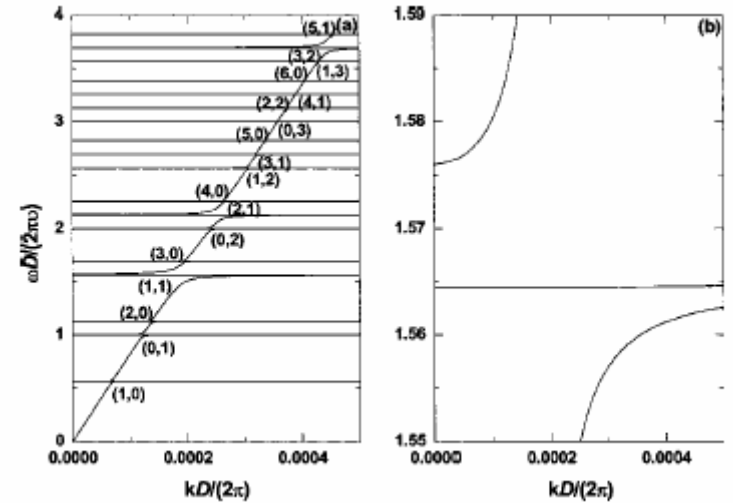
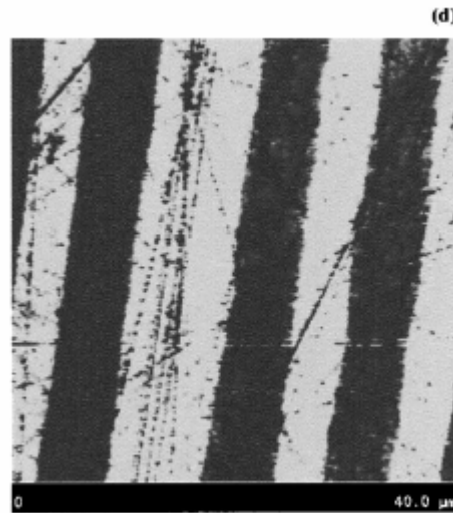
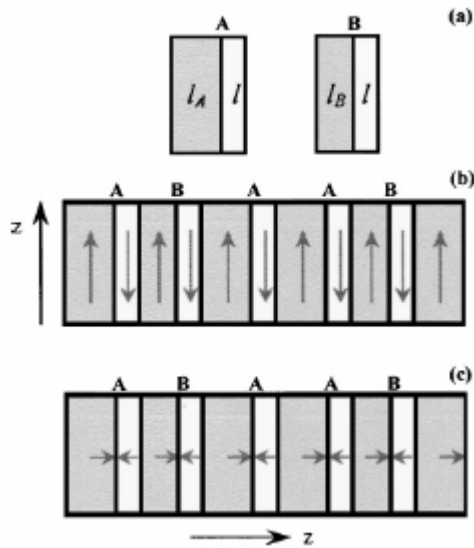

Dielectric funct.

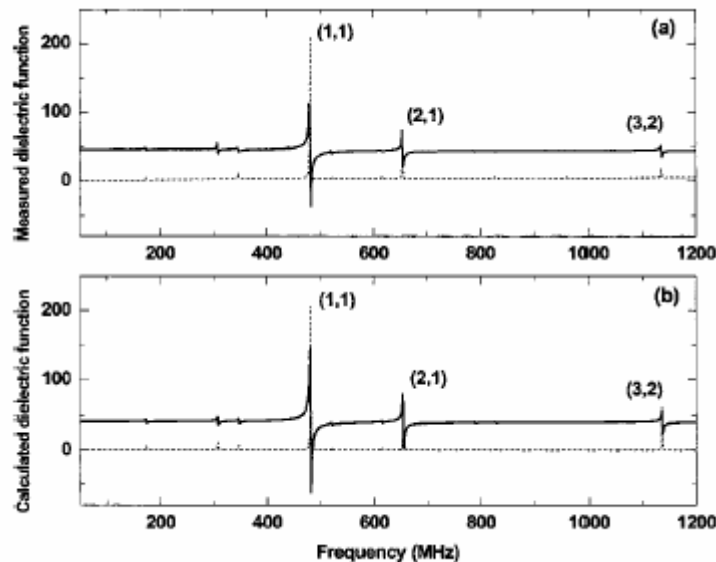

Polariton dispersion

APL 85, 3531 (2004)

# Piezo-coupling of polaritons

$$\begin{pmatrix} D_2 \\ D_3 \end{pmatrix} = \epsilon_0 \begin{pmatrix} \epsilon_{22}(\omega) & \epsilon_{23}(\omega) \\ \epsilon_{23}(\omega) & \epsilon_{33}(\omega) \end{pmatrix} \begin{pmatrix} E_2 \\ E_3 \end{pmatrix}$$

$$\epsilon_{22}(\omega) = \epsilon_{11}^S + \frac{8e_{22}^2/d^2\rho\epsilon_0}{\omega_L^2 - \omega^2 - i\gamma\omega}$$

$$\epsilon_{23}(\omega) = -\frac{8e_{22}e_{31}/d^2\rho\epsilon_0}{\omega_L^2 - \omega^2 - i\gamma\omega}$$

$$\epsilon_{33}(\omega) = \epsilon_{33}^S + \frac{8e_{31}^2/d^2\rho\epsilon_0}{\omega_L^2 - \omega^2 - i\gamma\omega}$$

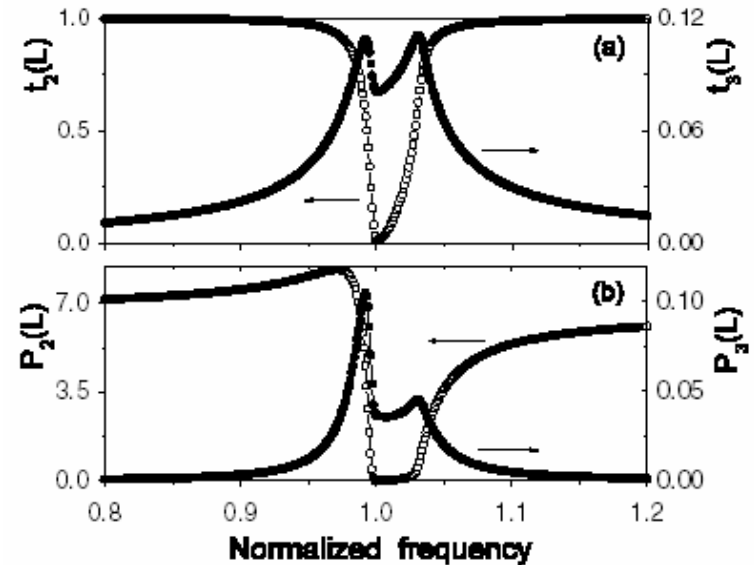

FIG. 3. Variation of the electric fields (a), and the PFD (normalized to  $\frac{1}{2}\epsilon_0 c |E_{20}|^2$ ) (b) with the frequency. The energy is transferred between  $E_2$  and  $E_3$  due to piezoelectric-induced coupling.

- Two polariton modes
- Coupling related to piezo-effect
- Due to coupling, one mode has gap, the other one no gap
- Periodicity  $\ll$  EM wavelength, subwavelength structure

# Content

- Introduction
- Piezoelectric superlattice
  - Piezoelectric transducer
  - Polariton: Superlattice vibration
- Polariton in a plasmonic crystal
- Conclusions

# Plasmonic materials & Surface plasmon polariton

- Surface plasmon polariton (SPP)—**light on the metal surface**

Generally, the electrons cannot pass through an insulator, and the light cannot propagate in a metal:

$$k = (\omega / c) \sqrt{\epsilon_m},$$

$$\epsilon_m = 1 - \omega_p^2 / \omega^2$$

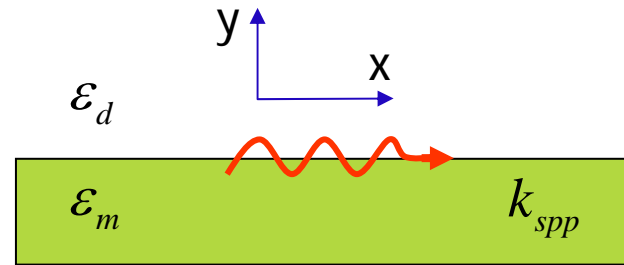

At the metal surface:

$$k_x = \sqrt{k_0^2 \epsilon_m - k_y^2} > 0 \quad (k_y = i |k_y|)$$

- **SPP is a wave** that propagates along the metal surface but evanescent on either side, where the photons couple strongly with the surface charges.

$$k_{spp} = \frac{\omega}{c} \sqrt{\frac{\epsilon_m \epsilon_d}{\epsilon_m + \epsilon_d}}$$

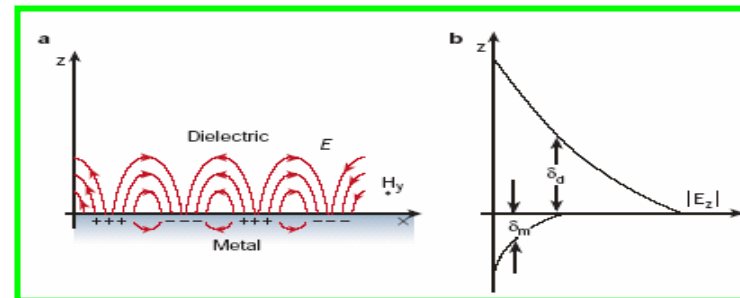



# Novel effects & potential applications

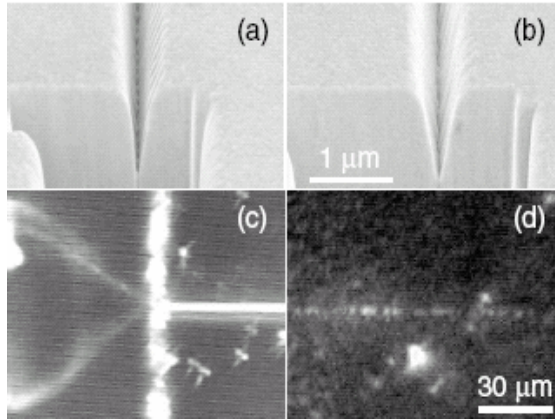

## • Plasmonic waveguides

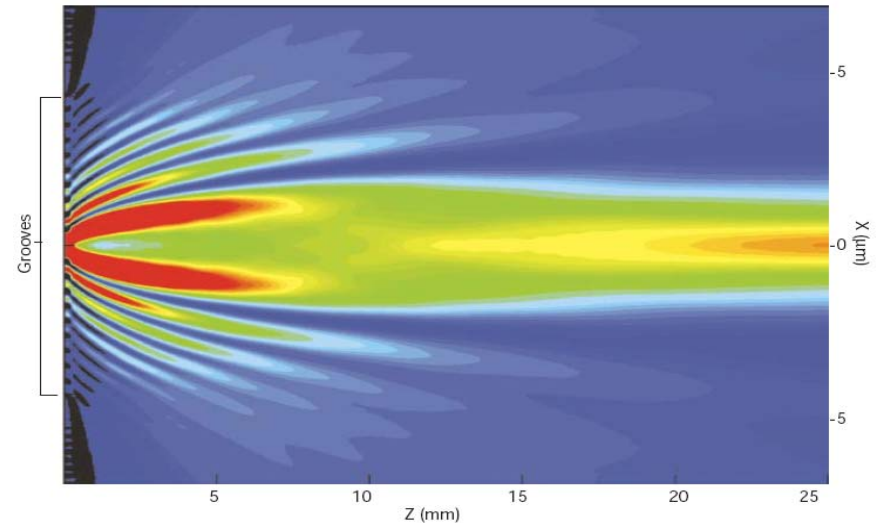
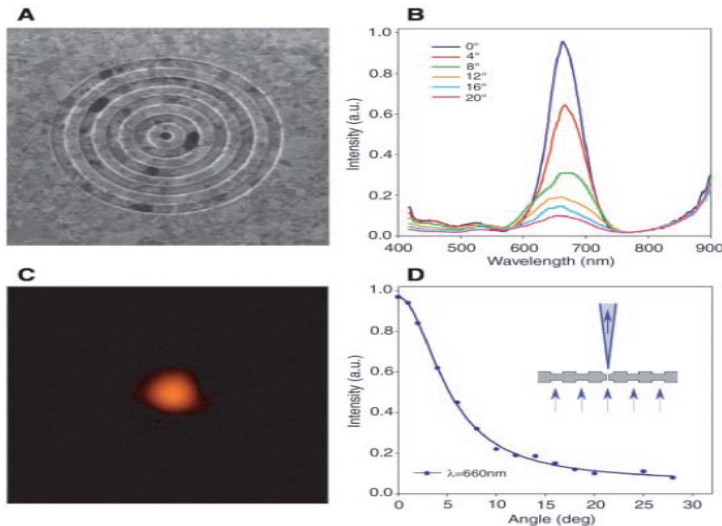
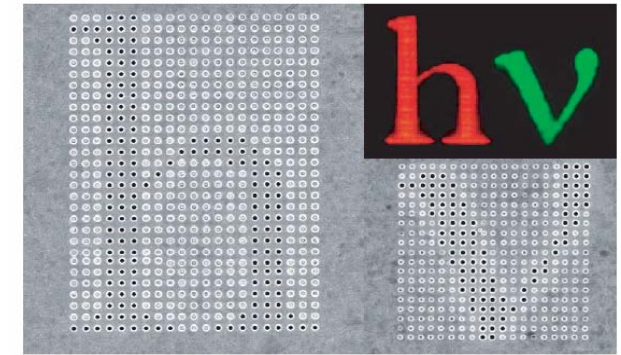
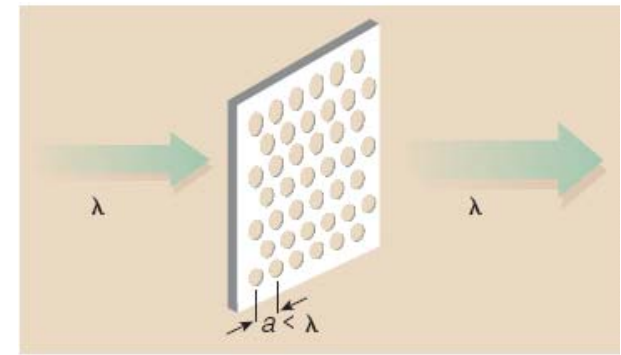
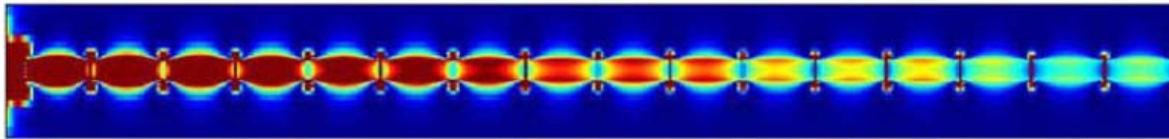
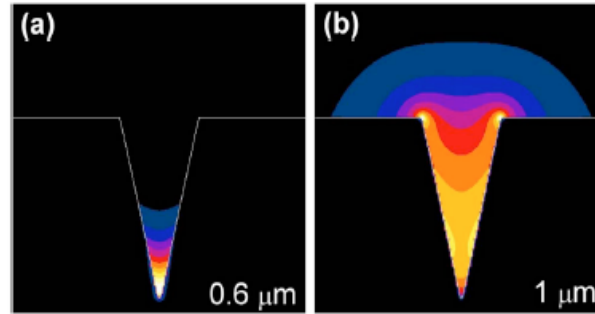

## • Plasmonic transmission [Nature 391, 667 (1998) & Science 297, 820 (2002)]

# Novel effects & potential applications

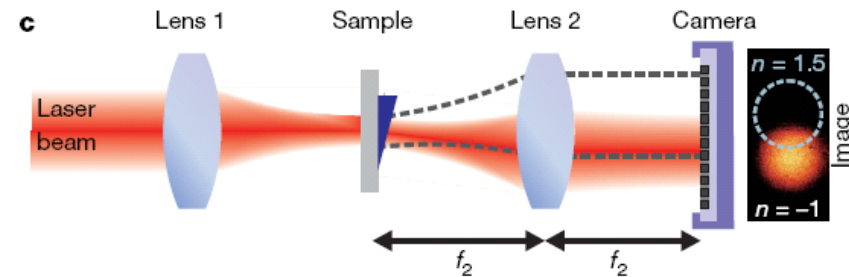
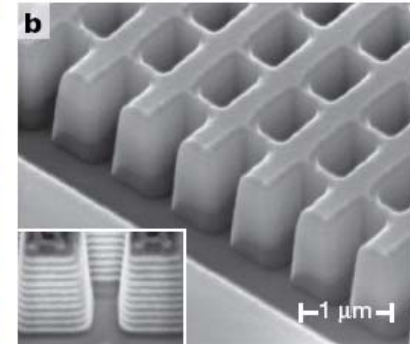
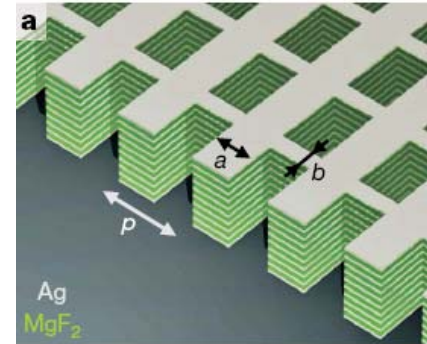
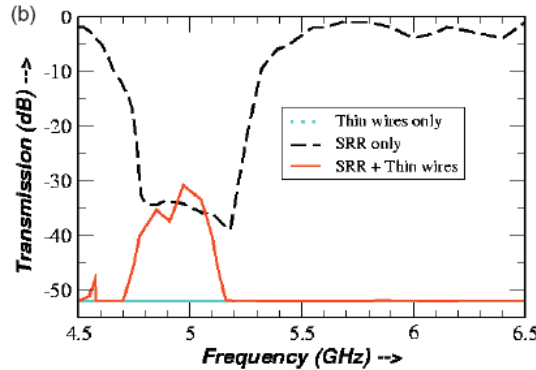
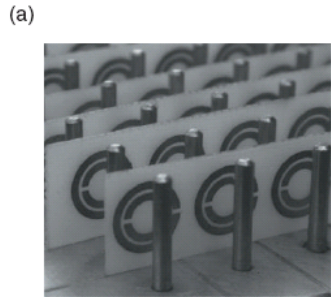
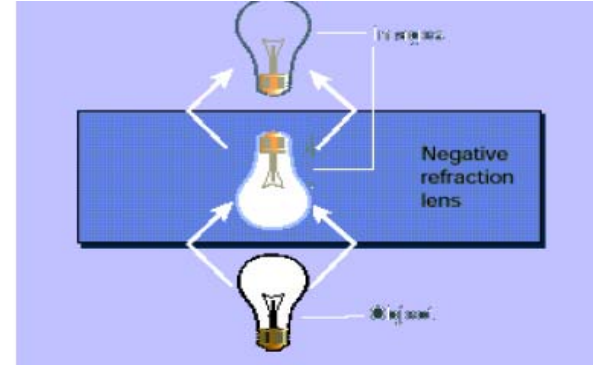
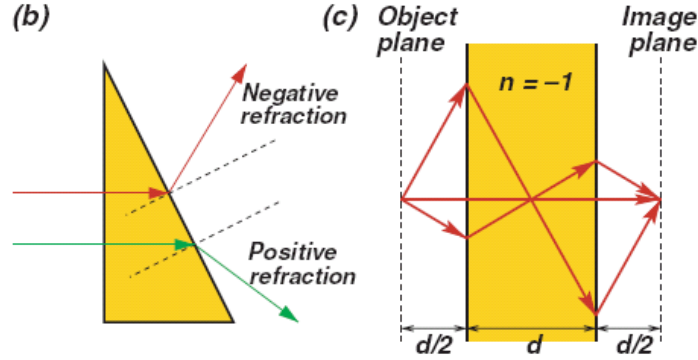
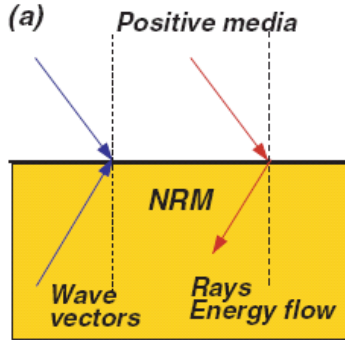

Science 292, 77 (2001)

- Negative refraction (perfect lens)**

Metallic wire + SRR (microwave band)

Multilayer fishnet structure (optical freq.)

Nature 455, 376 (2008)

# Novel effects & potential applications

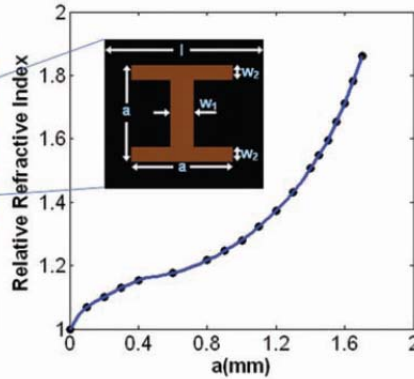
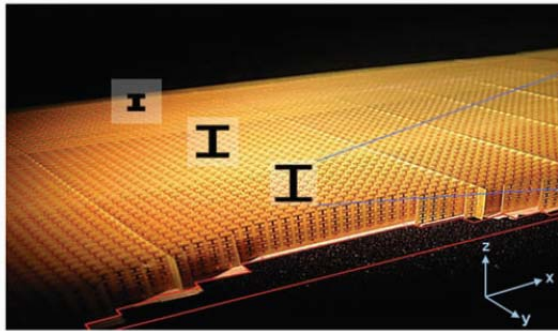
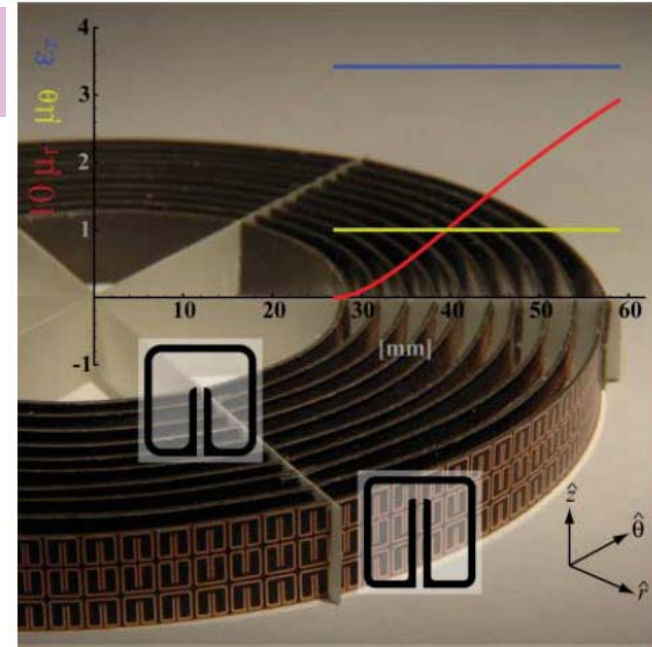
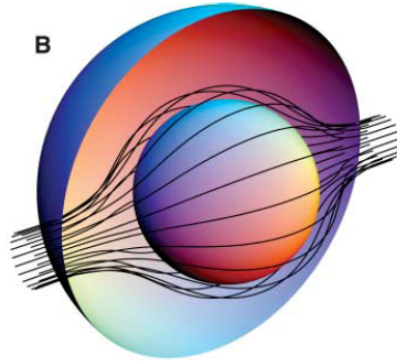
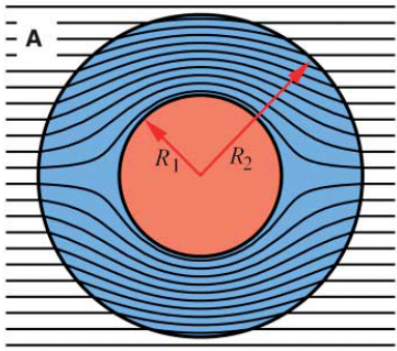

Science 2006 & 2009

• Cloaking with metamaterial

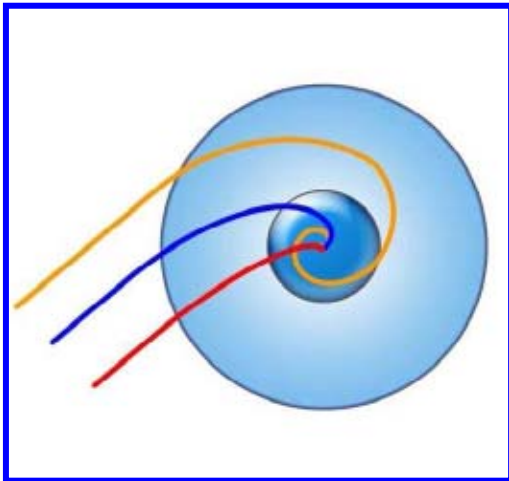

N.J.Phys.12, 063006 (2010)



• Optical black hole

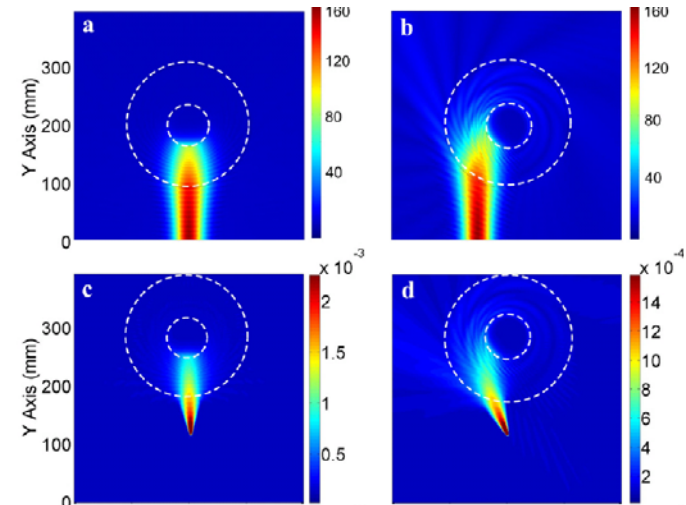

# Long-wavelength optical properties of a plasmonic crystal

Stop band by Bragg reflection: **photonic** stop band

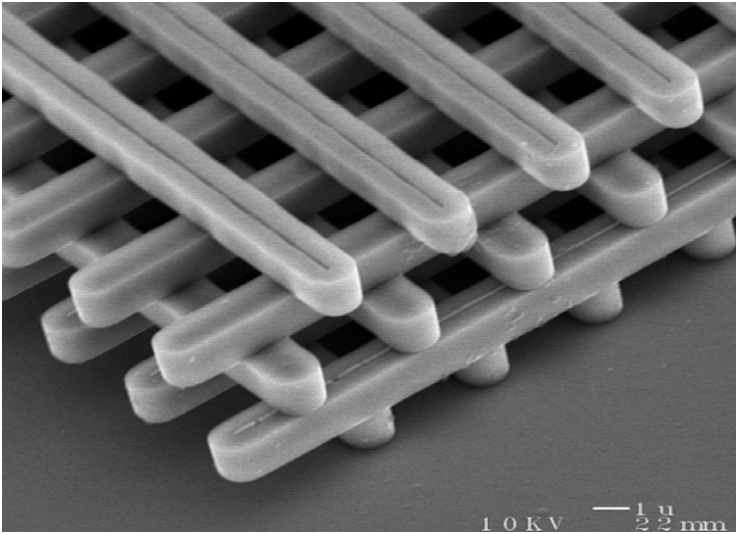

3D metal-dielectric PC

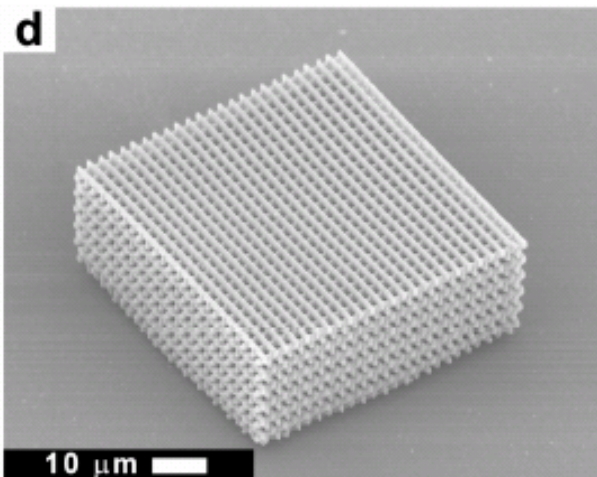
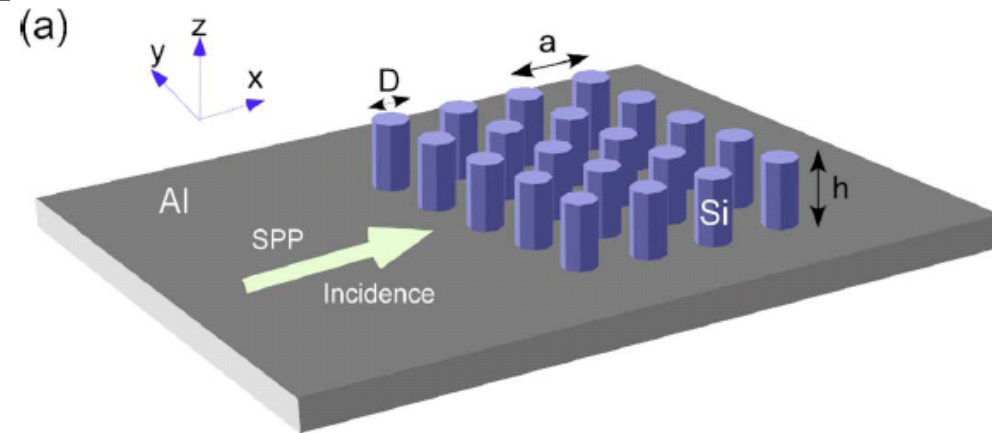
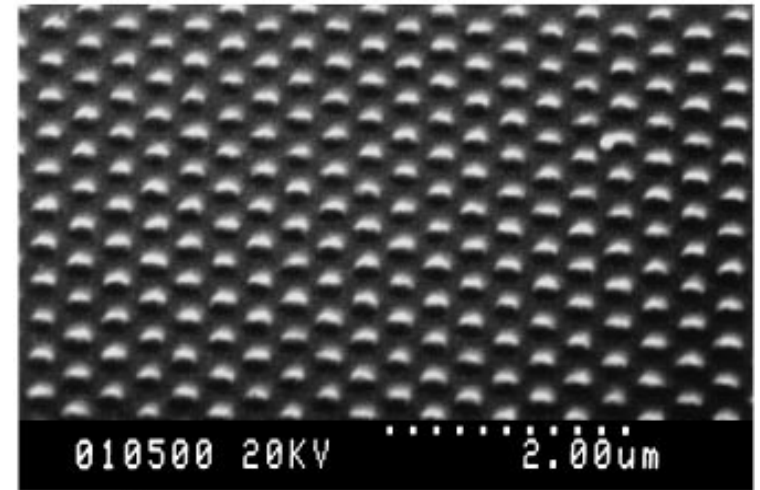

Kitson et al., Phys.Rev.Lett. 77, 2670 (1996)  
Feng et al., Appl.Phys.Lett. 93, 231105 (2008)

# Stop band by coupling effect: polaritonic stop band

## Ionic crystal

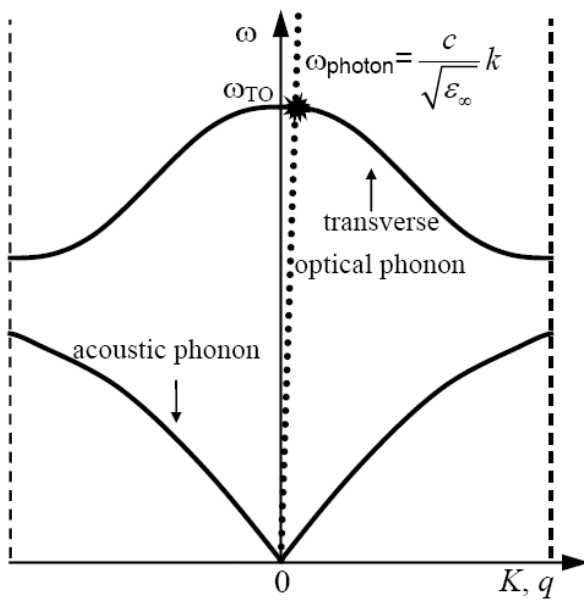
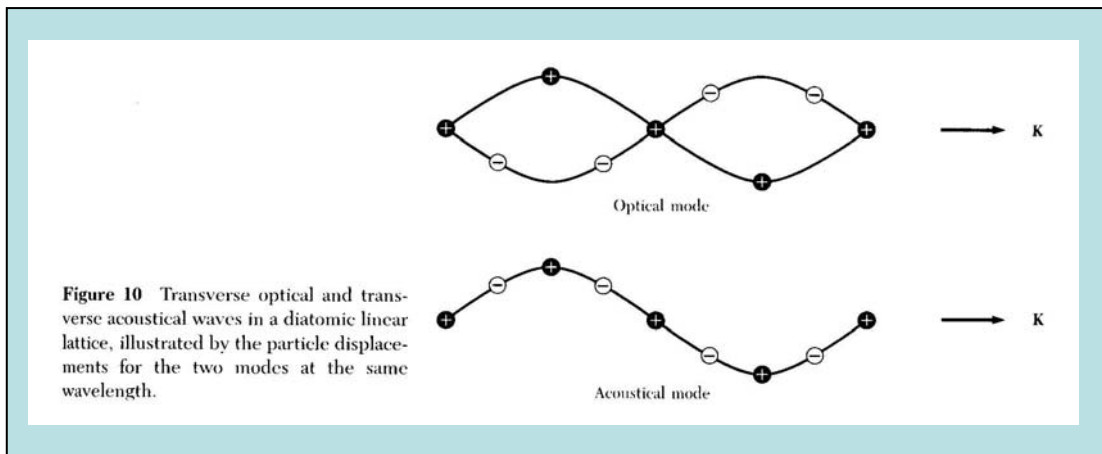

$$\begin{cases} \ddot{\mathbf{W}} = b_{11} \mathbf{W} + b_{12} \mathbf{E} \\ \mathbf{P} = b_{21} \mathbf{W} + b_{22} \mathbf{E} \end{cases}$$

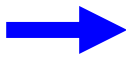

Long-wavelength optical properties

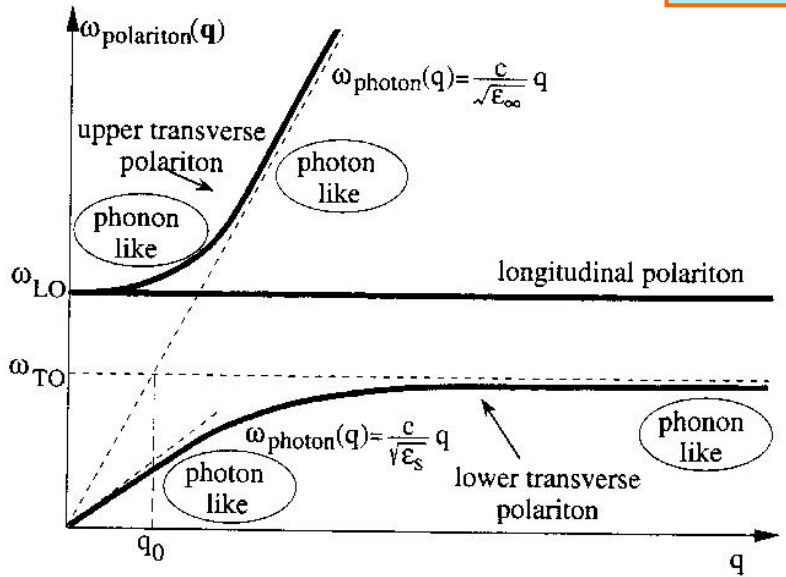

**Polariton is a mixed state of photon and polarization wave**

In an ionic crystal, the strong coupling between the photons and transverse optical phonons leads to phonon polariton and a stop band.

## Similarities between ionic and plasmonic crystals

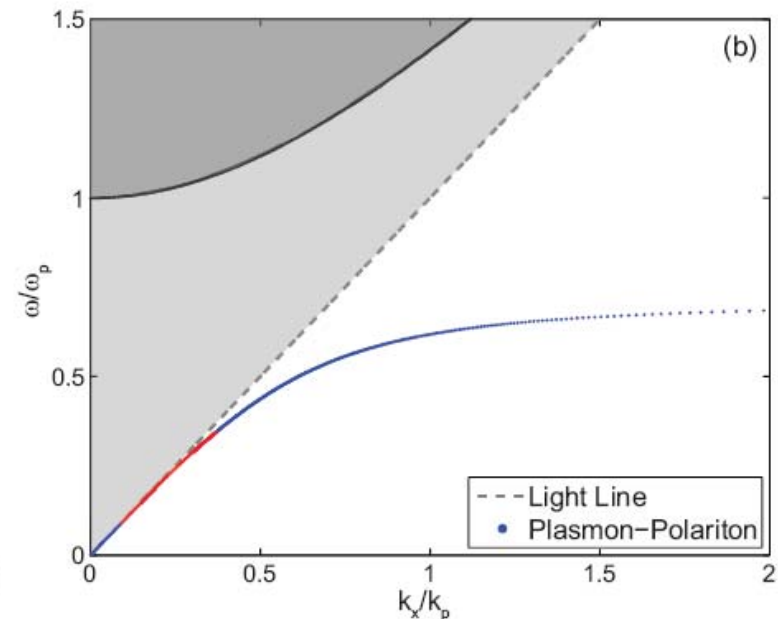
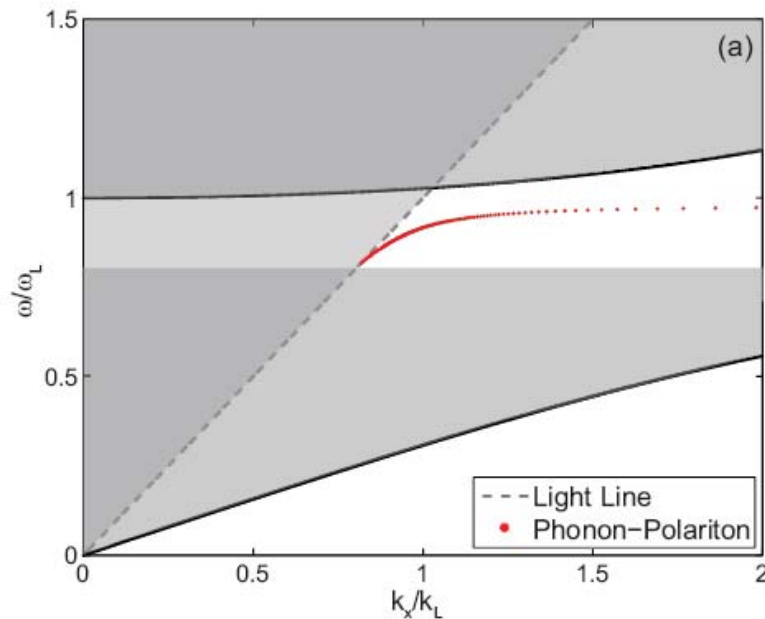

$$k_{\text{SPP}}(\omega) = \frac{\omega}{c} \sqrt{\frac{\epsilon_1(\omega)\epsilon_2}{\epsilon_1(\omega) + \epsilon_2}}$$

$$\epsilon_1(\omega) = \epsilon_\infty \frac{\omega_L^2 - \omega^2 + i\gamma\omega}{\omega_T^2 - \omega^2 + i\gamma\omega}$$

$$\epsilon_1(\omega) = \epsilon_\infty - \frac{\omega_p^2}{\omega(\omega + i\gamma)}$$

**Surface modes:** Surface phonon polariton & surface plasmon polariton

*Enhanced transmission through perforated films* **[PRB 75, 075422 (2007)]**

# Similarities between ionic and plasmonic crystals

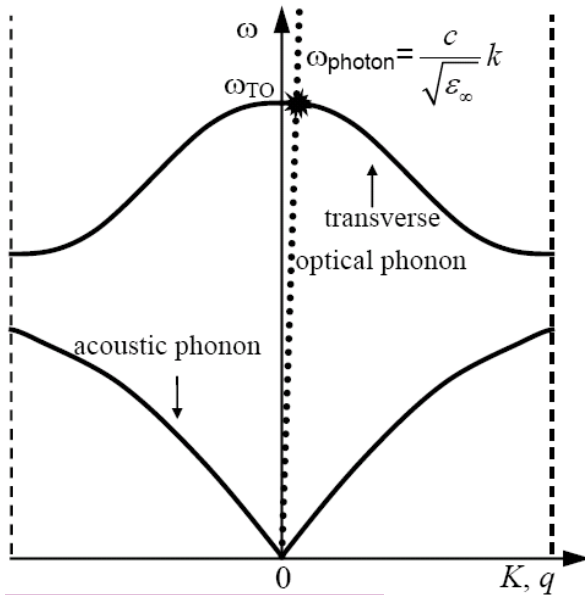

Ionic lattice

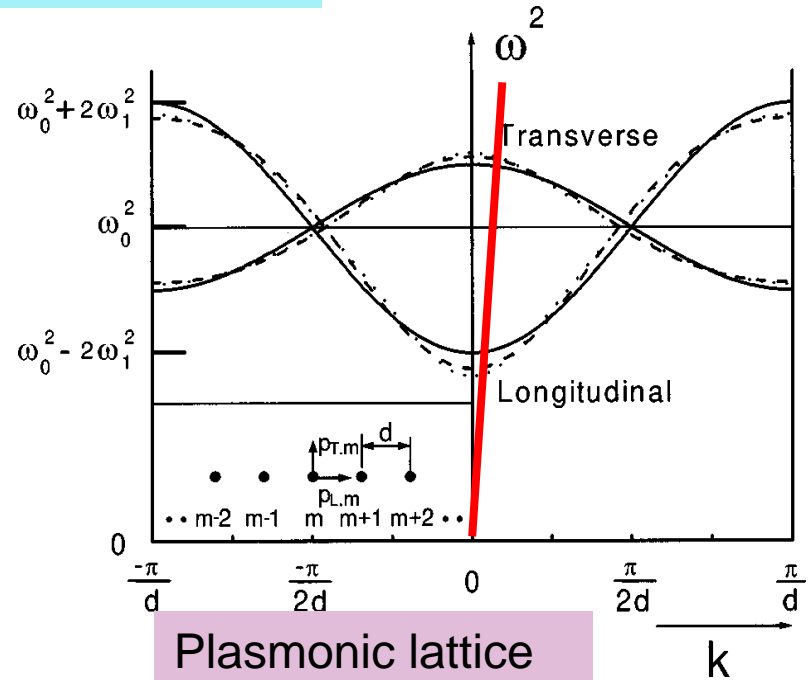

Plasmonic lattice

| Ionic crystals           | Plasmonic crystals       |
|--------------------------|--------------------------|
| Lattice vibration        | Plasma oscillation       |
| Dipole moments           | Dipole moments           |
| Transverse optical waves | Transverse plasmon waves |

Therefore, because of strong coupling between light and transverse plasmon wave (vibrations of free electrons), a bulk polariton mode can be present in a PC.

How to understand the electronic  
motion/plasmon resonance in the gold  
nanorod?



## A) AC resistance

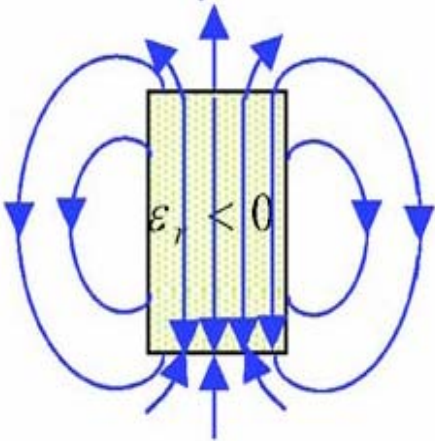

$$\nabla \times H = J + \frac{\partial P}{\partial t} + \epsilon_0 \frac{\partial E}{\partial t} = \frac{\partial D}{\partial t},$$

$$D = \epsilon_0 \epsilon_m E,$$

$$\epsilon_m = \epsilon_\infty + \frac{i\sigma}{\epsilon_0 \omega} = \epsilon_\infty - \frac{\omega_p^2}{\omega(\omega + i\gamma)}.$$

Conduction current is dominant in a metal!

$$m \ddot{r} = -eE - \gamma m \dot{r} \Rightarrow J = -nev = \sigma E \quad \left( \sigma = \frac{\sigma_0}{1 - i\omega\tau}, \quad \sigma_0 = \frac{ne^2\tau}{m} \right)$$

$$R = \frac{1}{\sigma} \frac{l}{s} = \frac{1 - i\omega\tau}{\sigma_0} \frac{l}{s}$$

$$= \frac{l}{\sigma_0 s} - i\omega \frac{\mu_0 l}{k_p^2 s}$$

$$= R_0 - i\omega L_0$$

The electron mass/inertia plays a role of inductance!

$$W_e = \frac{1}{2} (nsl) m v^2$$

$$= \frac{1}{2} (nsl) m \left( \frac{I}{nes} \right)^2 = \frac{1}{2} L_0 I^2$$

$$L_0 = ml / ne^2 s = \mu_0 l / k_p^2 s.$$

## B) Faraday inductance

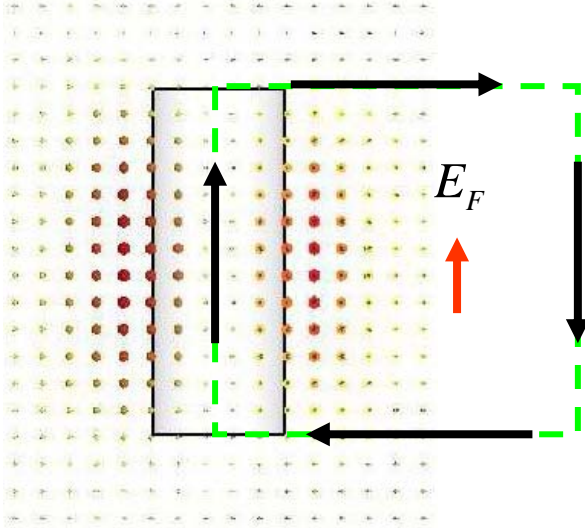

$$W_M = \frac{1}{2} LI^2 \Rightarrow L \approx \frac{\mu_0 l}{2\pi} \ln \frac{l}{2r_0}.$$

$$\mathcal{E}_F = E_F l = \oint E_F \cdot dl = -\frac{d\phi}{dt}$$

$$L = \phi / I \approx \frac{\mu_0 l}{2\pi} \ln \frac{l}{2r_0}.$$

$$(E_F = -\frac{\partial A}{\partial t} \propto \frac{\partial I}{\partial t})$$

## C) Capacitance

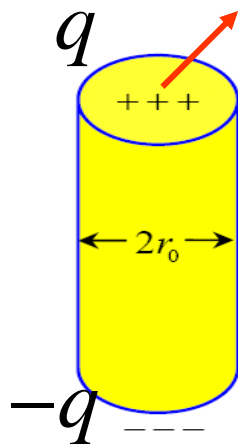
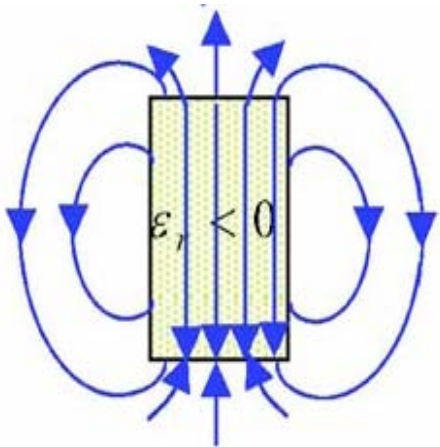

$$W_E = q^2 / 2C.$$

$$U_+ = -U_- = \frac{q / \alpha}{2\pi\epsilon_0\epsilon_d r_0}$$

$$C = \frac{q}{\Delta U} = \alpha\pi\epsilon_0\epsilon_d r_0.$$

Circuit theory:

$$\mathcal{E} = IZ \Rightarrow El = I\left(R - i\omega L - \frac{1}{i\omega C}\right)$$

$$p \approx ql = \frac{\varepsilon_0 A}{\omega_0^2 - \omega^2 - i\eta\omega} E$$

Newton's equation:

$$\begin{aligned} m \ddot{z} &= -e(E + E_C + E_F) - \gamma m \dot{z} & (q = -nesz) \\ &= -e\left(E - \frac{q}{Cl} - \frac{L}{l} \ddot{q}\right) - \gamma m \dot{z} \end{aligned}$$

$$(m + \sigma L) \ddot{z} = -(\sigma / C)z - \gamma m \dot{z} - Ee. \quad (\sigma = ne^2 s / l)$$

- The free electrons act as forced harmonic oscillators (an effective restoring force & an increased electron mass)!
- The self-inductance plays a role of electron inertia!  
(The electron mass/inertia plays a role of inductance!)

OK!

## Bulk plasmon-polariton in a plasmonic crystal composed of gold nanorod particles

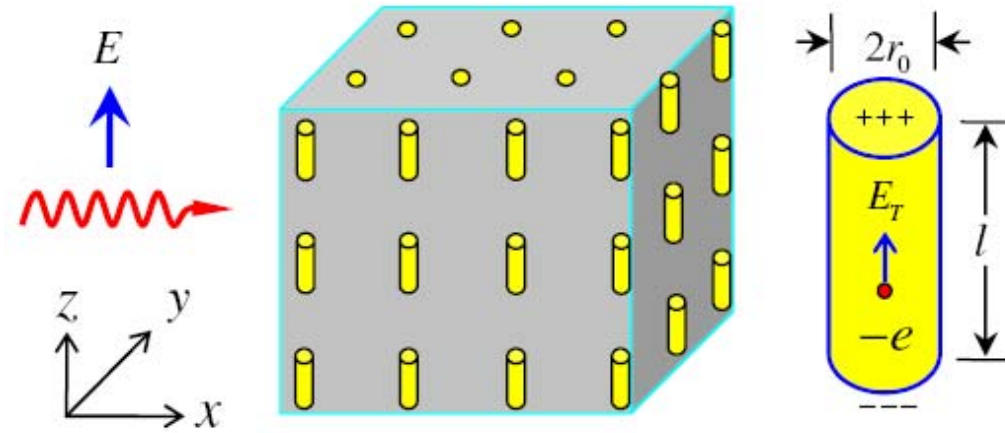

$$\ddot{W} = -\left(\omega_o^2 - \frac{Q^2}{3\varepsilon_0\varepsilon_d M\Omega}\right)W + \frac{Q}{(M\Omega)^{1/2}}E,$$

$$P = \frac{Q}{(M\Omega)^{1/2}}W + \varepsilon_0(\varepsilon_d - 1)E.$$

- We proposed that the HK equation, which was established originally for an ionic crystal where a strong coupling between the photons and lattice vibrations is present, may be extended to the plasmonic lattice (in the long-wavelength limit).
- Starting from the classical motion equation of free electrons, the governing equation for the plasmonic crystal has been deduced, showing indeed the same format as Huang's Equation.

$$\ddot{W} = b_{11}W + b_{12}E,$$

$$P = b_{21}W + b_{22}E.$$

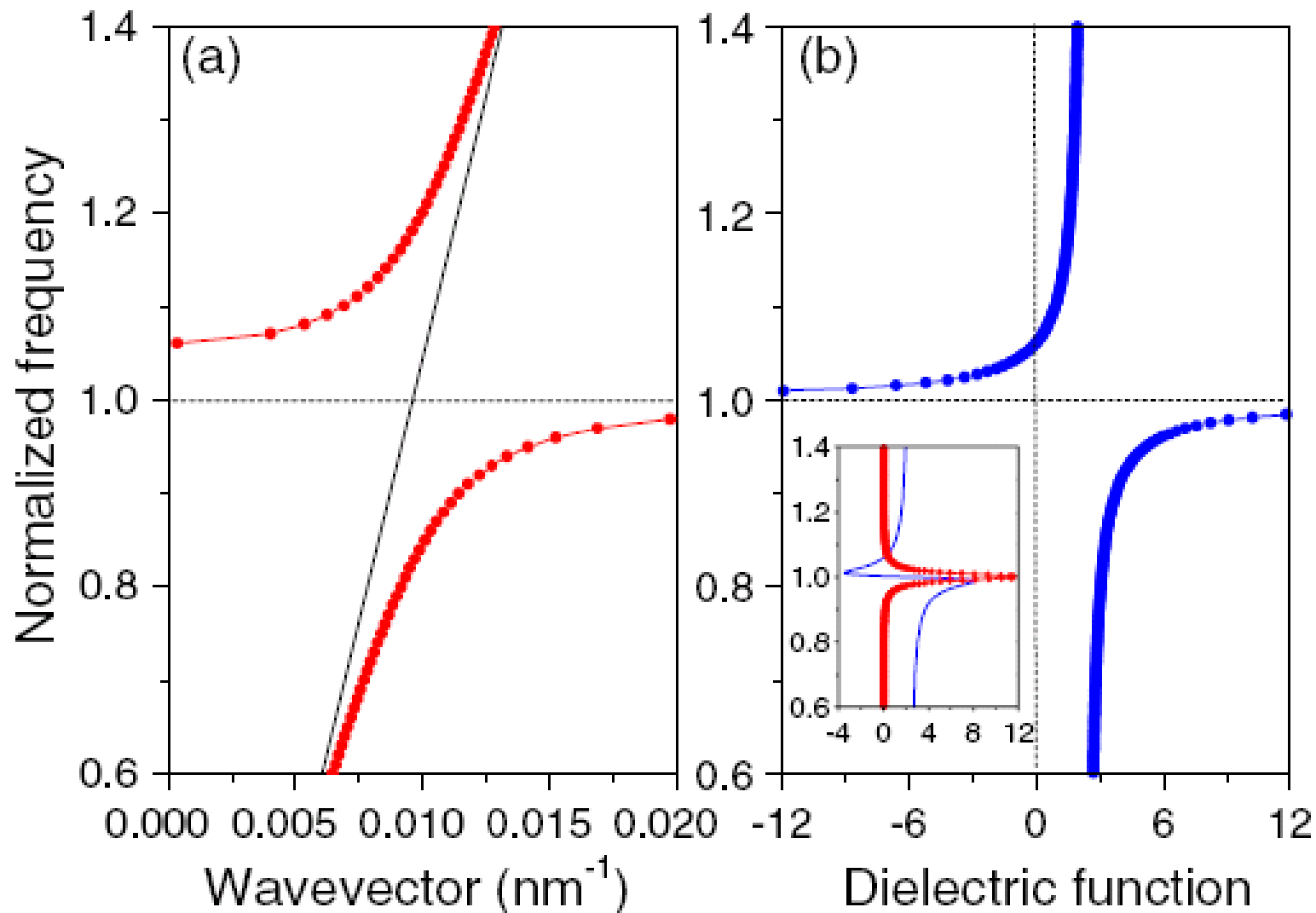

Because of the strong coupling, a polaritonic stop band is created.

# Analytical result vs numerical simulations

$$t = \left| \frac{4k_0 k \exp(ikh)}{(k_0 + k)^2 - (k_0 - k)^2 \exp(2ikh)} \right|^2.$$

$$\frac{c^2 k^2}{\omega^2} = \varepsilon_d + \frac{fm / m_{eff}}{\omega_s^2 - \omega^2} \omega_p^2,$$

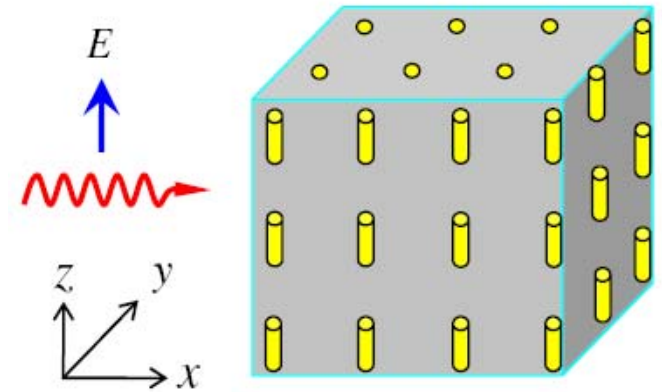

- To demonstrate the polariton effect, we have calculated the transmission spectrum of a plasmonic crystal film both analytically and numerically.
- The lattice constant is 80nm, the permittivity of host medium is 2.25, and the length and diameter of nanorod is 40nm and 10nm respectively (the film thickness is 1600nm, 20 unit-cell thick).

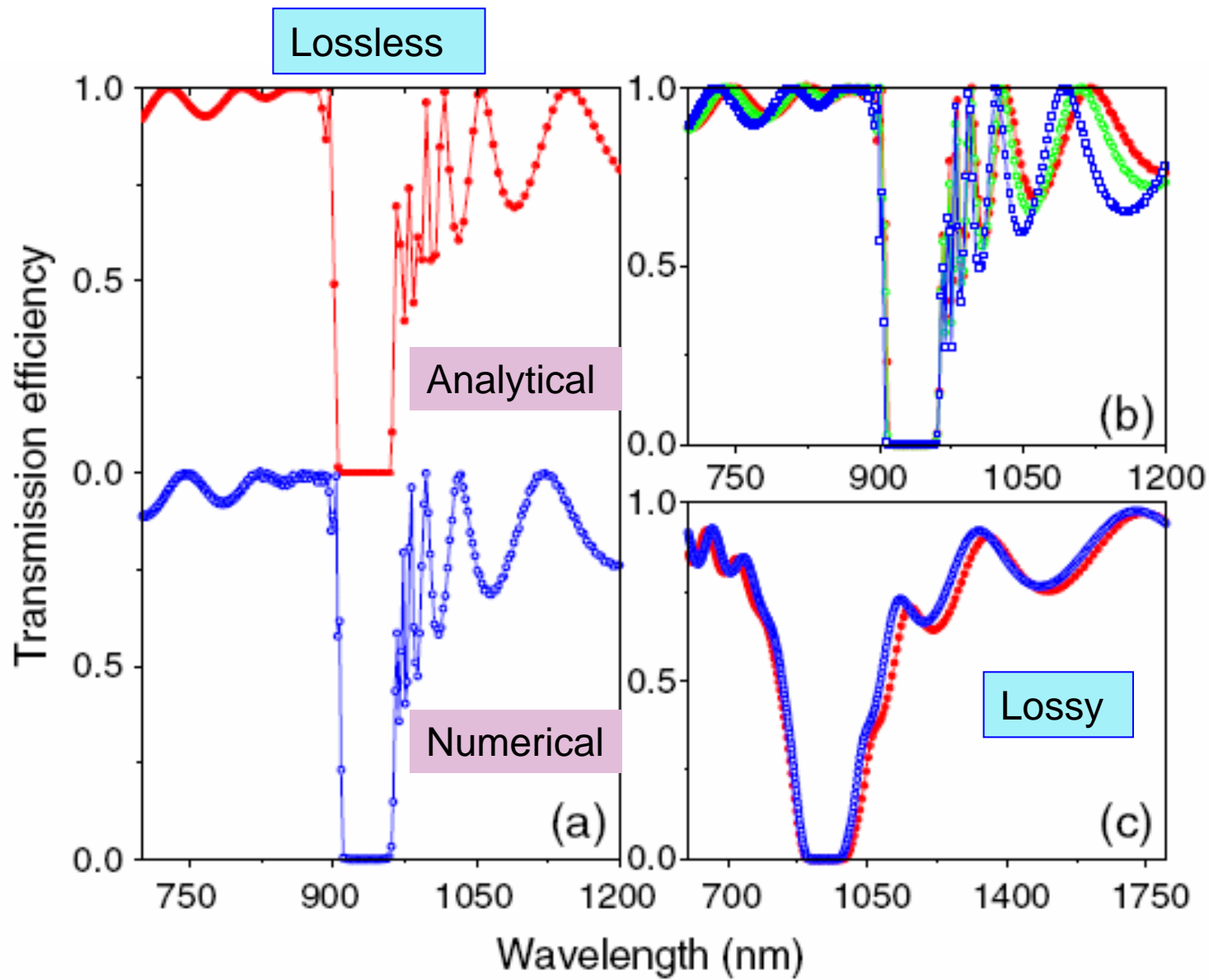

# conclusions

- Polariton: a mixed state of photon and polarization wave
- Stop band:
  - by Bragg reflection: **photonic** stop band
  - by coupling effect: **polaritonic** stop band





*Thank you for your  
attention!*